



Type CW Power Relay Zero Degree Characteristic

Effective: December 1993

Supersedes I.L. 41-241.2C Dated May 1967

(|) Denotes Change Since Previous Issue



Before putting relays into service, remove all blocking which may have been inserted for the purpose of securing the parts during shipment, make sure that all moving parts operate freely, inspect the contacts to see that they are clean and close properly and operate the relay to check the settings and electrical connections.

1. APPLICATION

The type CW relay is a single phase induction type relay providing over-power or reverse-power protection for electrical equipment or circuits. It is not intended for use as a fault protective relay.

2. CONSTRUCTION

The relay consists of a product operated unit, a phase shifter and a indicating contactor switch (ICS) as shown in Figure 1.

2.1. Product Type Unit

The electromagnet for the main element has a tapped current coil located on the center leg of an "E" type laminated structure and two potential coils on the outer legs. Operating torque is obtained by energizing the tapped coil with line current and the two outer coils with line potential from the line potential transformers. Out of phase air gap fluxes necessary

for operating torques are produced by a phase shifting network in conjunction with the potential coils. Maximum torque occurs when the current and voltage are in phase. The voltage is independent of the direction of power flow. This provides a reference so that the disc can rotate in either direction depending upon direction of the line current. The combination of voltage and current produces an operating torque proportional to power.

2.1.1. Phase Shifter

The Phase Shifter network consists of a capacitor in parallel with the potential coils and a reactor in series with the above combination. See internal schematic Figures 2 and 3.

2.2. Indicating Contactor Switch Unit (ICS)

The dc indicating contactor switch is a small clapper type device. A magnetic armature, to which leaf-spring mounted contacts are attached, is attracted to the magnetic core upon energization of the switch. When the switch closes, the moving contacts bridge two stationary contacts, completing the trip circuit. Also during this operation two fingers on the armature deflect a spring located on the front of the switch, which allows the operation indicator target to drop. The target is reset from the outside of the case by a push rod located at the bottom of the cover.

The front spring, in addition to holding the target, provides restraint for the armature and thus controls the pickup value of the switch.

All possible contingencies which may arise during installation, operation or maintenance, and all details and variations of this equipment do not purport to be covered by these instructions. If further information is desired by purchaser regarding this particular installation, operation or maintenance of this equipment, the local ABB Power T&D Co. Inc. representative should be contacted.

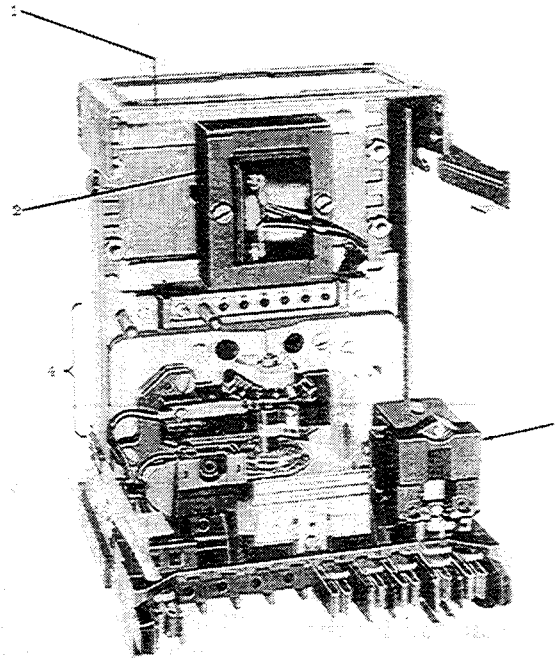

Figure 1. Type CW Relay Without Case. (1) Capacitor. (2) Reactor. (3) Indicating Contactor Switch (ICS). (4) Time-Power Unit.

3. CHARACTERISTICS

The type CW relays are available in the following ranges and taps:

SINGLE PHASE WATT RANGE	POTENTIAL COIL	TAPS
20 - 120	120	20-30-40-60-80-100-120
100 - 600	120	100-150-200-300-400-500-600

Typical 60 cycle Time-Power Curves are shown in Figures 4 and 5. The curves are taken at maximum torque which occurs with the current and voltage in phase (within $\pm 4^\circ$).

3.1. Trip Circuit

The main contacts will safely close 30 amperes at 250 volts dc and the seal-in contacts of the indicating contactor switch will safely carry this current long enough to trip a circuit breaker.

The indicating contactor switch has two taps that provide pickup setting of 0.2 or 2 amperes. To change

taps requires connecting the lead located in front of the tap block to the desired setting by means of a screw connection.

3.2. Trip Circuit Constant

Indicating Contactor Switch (ICS)
 0.2 ampere tap 6.5 ohms dc resistance
 2.0 ampere tap 0.15 ohms dc resistance

4. INSTALLATION

The relays should be mounted on switchboard panels or their equivalent in a location free from dirt, moisture, excessive vibration and heat. Mount the relay vertically by means of the four mounting holes on the flange for semi-flush mounting or by means of the rear mounting stud or studs for projection mounting. Either a mounting stud or the mounting screws may be utilized for grounding the relay. The electrical connections may be made directly to the terminals by means of screws for steel panel mounting or to the terminal studs furnished with the relay for thick panel mounting. The terminal studs may be easily removed or inserted by locking two nuts on the stud and then turning the proper nut with a wrench.

For detailed FT case information refer to I.L. 41-076.

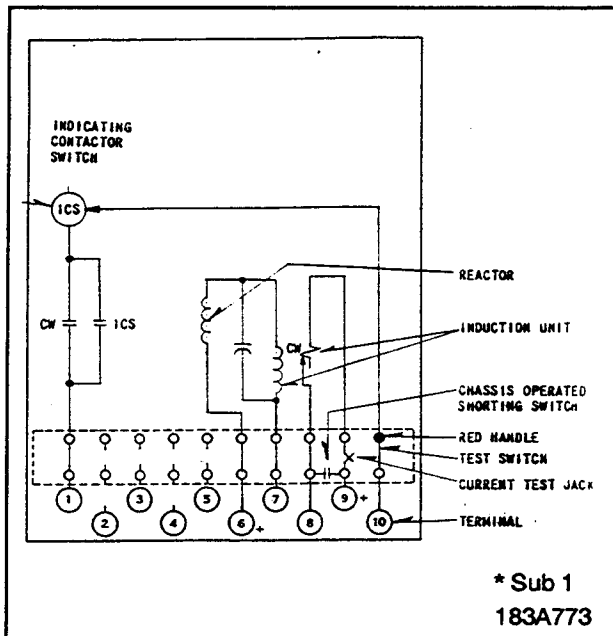

Figure 2. Internal Schematic of the Type CW Relay in the Type FT 21 Case.

* Denotes Change

5. SETTINGS

5.1. Product Unit

There are two settings to be made. One is the current tap setting, and the second, the time dial setting.

The power to operate the relay equals the primary power divided by the current and potential transformer ratios. This relay power expressed as multiples of the chosen tap locates a value on the abscissa of the Time-Power Curves of Figures 4 and 5. The relay operating time for various time dial settings then is observed on the ordinate. By changing taps or time dial, the required operating time can be selected for a specific power value.

CAUTION

Since the tap block screw carries operating current, be sure that the screws are turned tight.

In order to avoid opening current transformer circuits when changing taps under load, start with RED handles FIRST and open all switchblades. Chassis operating shorting switches on the case will short the secondary of the current transformer. Taps may then be changed with

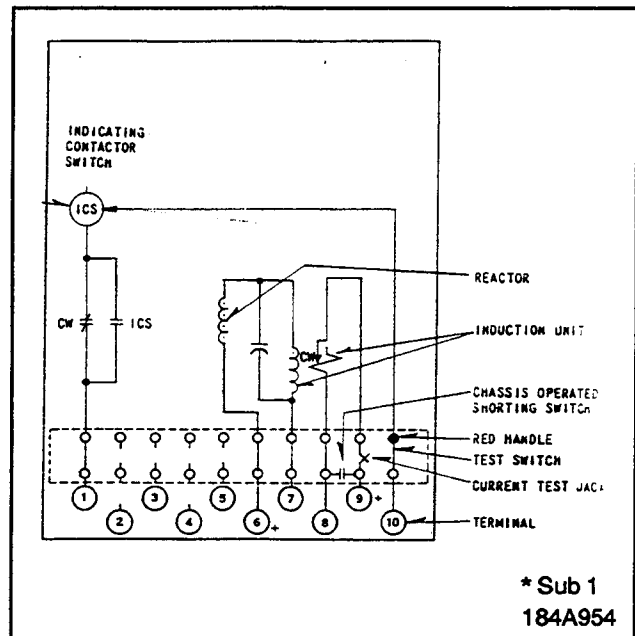

Figure 3. Internal Schematic of the Under Power Type CW Relay in the Type FT 21 Case.

* Denotes Change

the relay either inside or outside the case. Then reclose all switchblades making sure the RED handles are closed LAST.

5.2. Indicating Contactor Switch (ICS)

No setting is required on the ICS unit except the selection of the 0.2 or 2.0 ampere tap setting. This selection is made by connecting the lead located in front of the tap block to the desired setting by means of the connecting screw.

5.3. Performance Check

Connect the relay as shown in Figure 6 to check electrical performance.

6. ADJUSTMENT AND MAINTENANCE

The proper adjustments to insure correct operating of this relay have been made at the factory and should not be disturbed after receipt by the customer. If the adjustments have been changed, the relay taken apart for repairs, or if it is desired to check the adjustments at regular maintenance periods, the instructions below should be followed.

All contacts should be cleaned periodically. A contact burnisher S#182A836H01 is recommended for this purpose. The use of abrasive material for cleaning

contacts is not recommended, because of the danger of embedding small particles in the face of the soft silver and thus impairing the contact.

6.1. Product Unit

6.1.1. Contacts

The index mark on the movement frame will coincide with the "O" mark on the time dial when the stationary contact has moved through approximately one-half of its normal deflection. Therefore, the stationary contact resting against the backstop, the index mark is offset to the right of the "O" mark by approximately .020". The placement of the various time dial positions in line with the index mark will give operating times as shown on the respective Time-Current Curves.

6.1.2. Minimum Trip Watts

Set the time dial to position 6. Using the lowest tap setting, alternately apply tap value watts plus 3% and tap value watts minus 3% with the current and the voltage in phase. The moving contact should leave the backstop at tap value watts plus 3% and should return to the backstop at tap value watts minus 3%. The relay should be calibrated with 10 times tap value watts at the number six time dial position. Check several points on the typical time curves. Time curve calibration is effected by adjusting the position of the permanent magnet keeper.

6.2. Indicating Contactor Switch (ICS)

Close the main relay contacts and pass sufficient dc current through the trip circuit to close the contacts of the ICS. This value of current should not be greater than the particular ICS tap setting being used. The indicator target should drop freely.

7. ENERGY REQUIREMENTS

The 60 Hertz burdens of the type CW Relay Single Phase Application are as follows:

1. The 20-120 Watt, 120 Volt Relay

A.

Potential Circuit Burden at Rated Voltage	
Current Lags By	Volt Amperes
26.5°	5.4

B.

Current Coil at 5 Amperes		
Tap	Current Lags By	Volt Amperes
20	78°	16.2

2. The 100-600 Watt, 120 Volt Relay

A.

Potential Circuit Burden at Rated Voltage	
Current Lags By	Volt Amperes
20°	5.9

B.

Current Coil at 5 Amperes		
Tap	Current Lags By	Volt Amperes
100	67°	5.4

Current Coil Ratings

	Continuous	1 Sec.
20-120 Watt Range	5 Amperes	230 Amperes
100-600 Watt Range	8 Amperes	370 Amperes

8. RENEWAL PARTS

Repair work can be done most satisfactorily at the factory. However, interchangeable parts can be furnished to the customers who are equipped for doing repair work. When ordering parts always give the complete nameplate data.

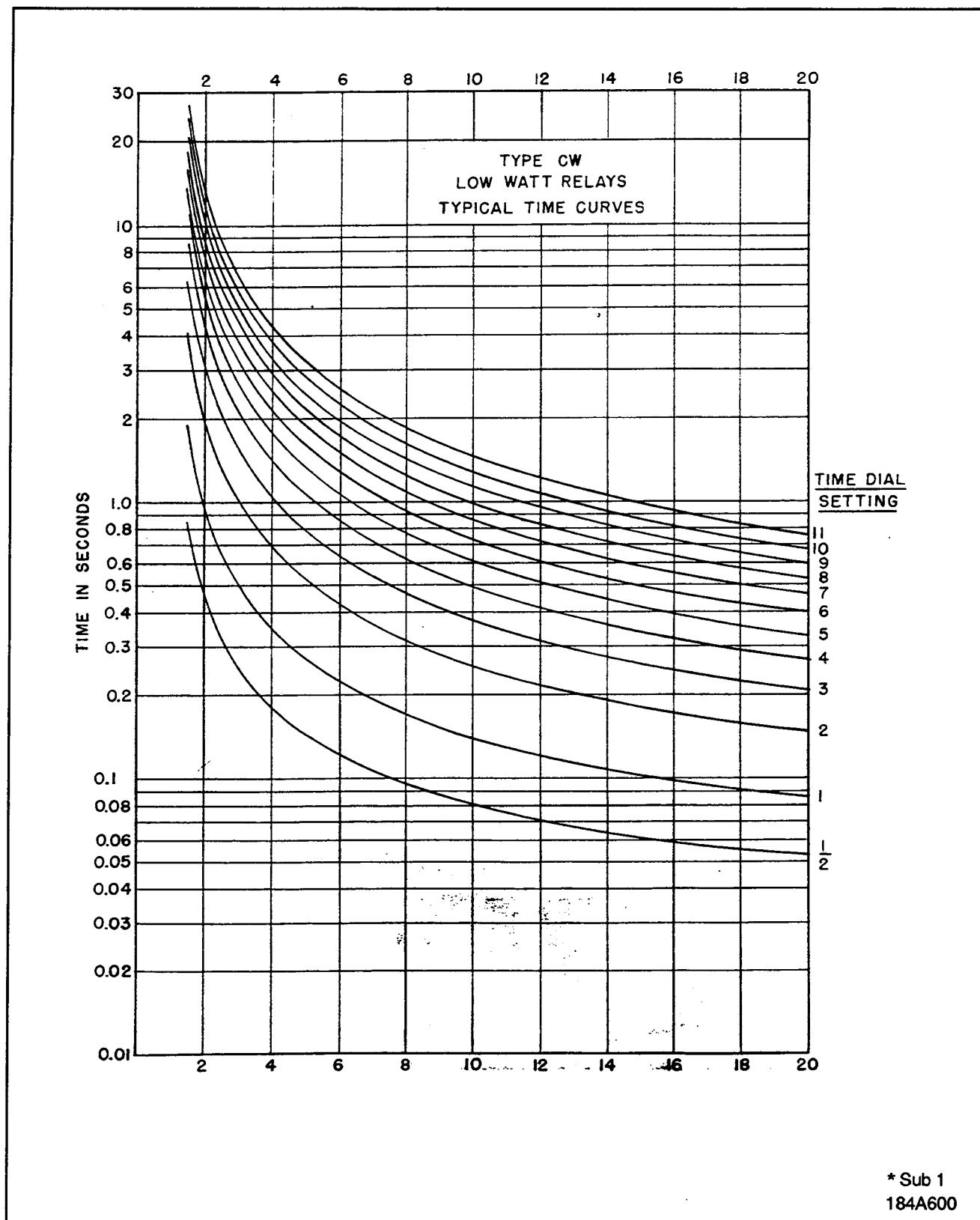
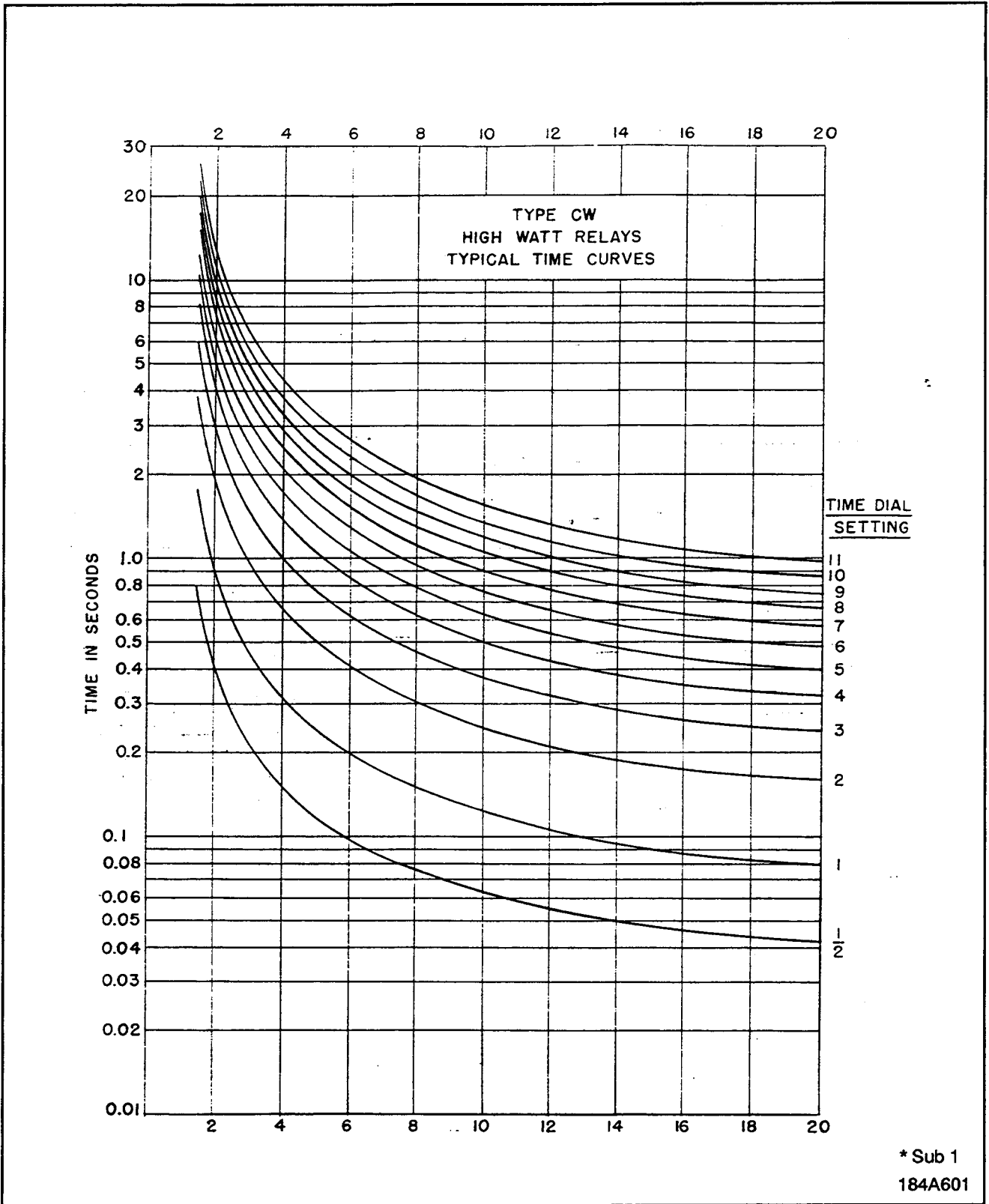

Figure 4. Typical 60 Hertz Time Curves of the 20-120 Watt Type CW Relay.

* Denotes Change

* Sub 1
184A600



* Sub 1
184A601

Figure 5. Typical 60 Hertz Time Curves of the 100-600 Watt Type CW Relay.

* Denotes Change

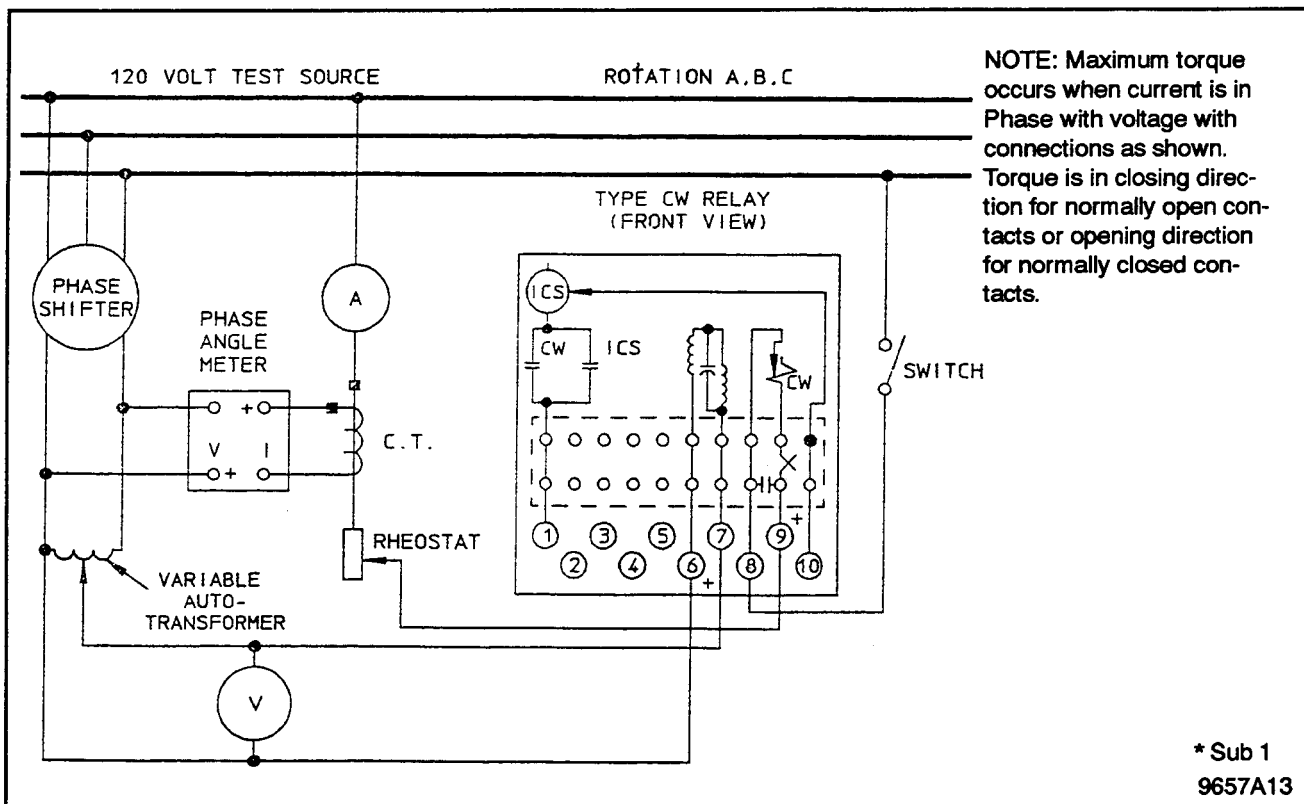

* Sub 1
9657A13

* Denotes Change

Figure 6. Diagram of Test Connections for Type CW Relay in FT 21 Case.

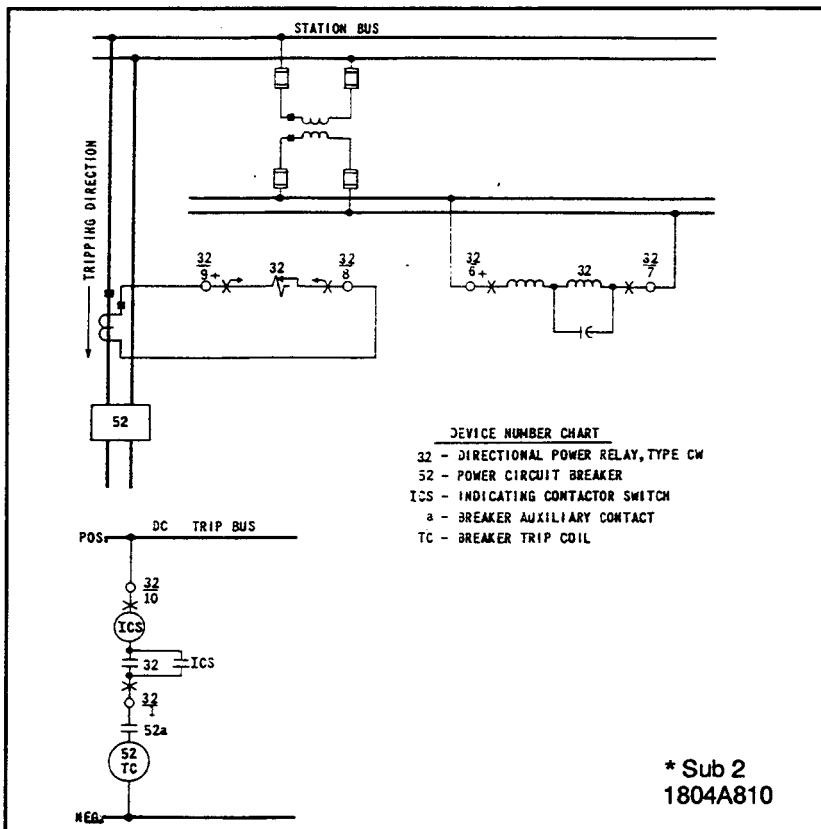

* Sub 2
1804A810

Figure 7. External Schematic of One Type CW Relay on a Single Phase System.

* Denotes Change

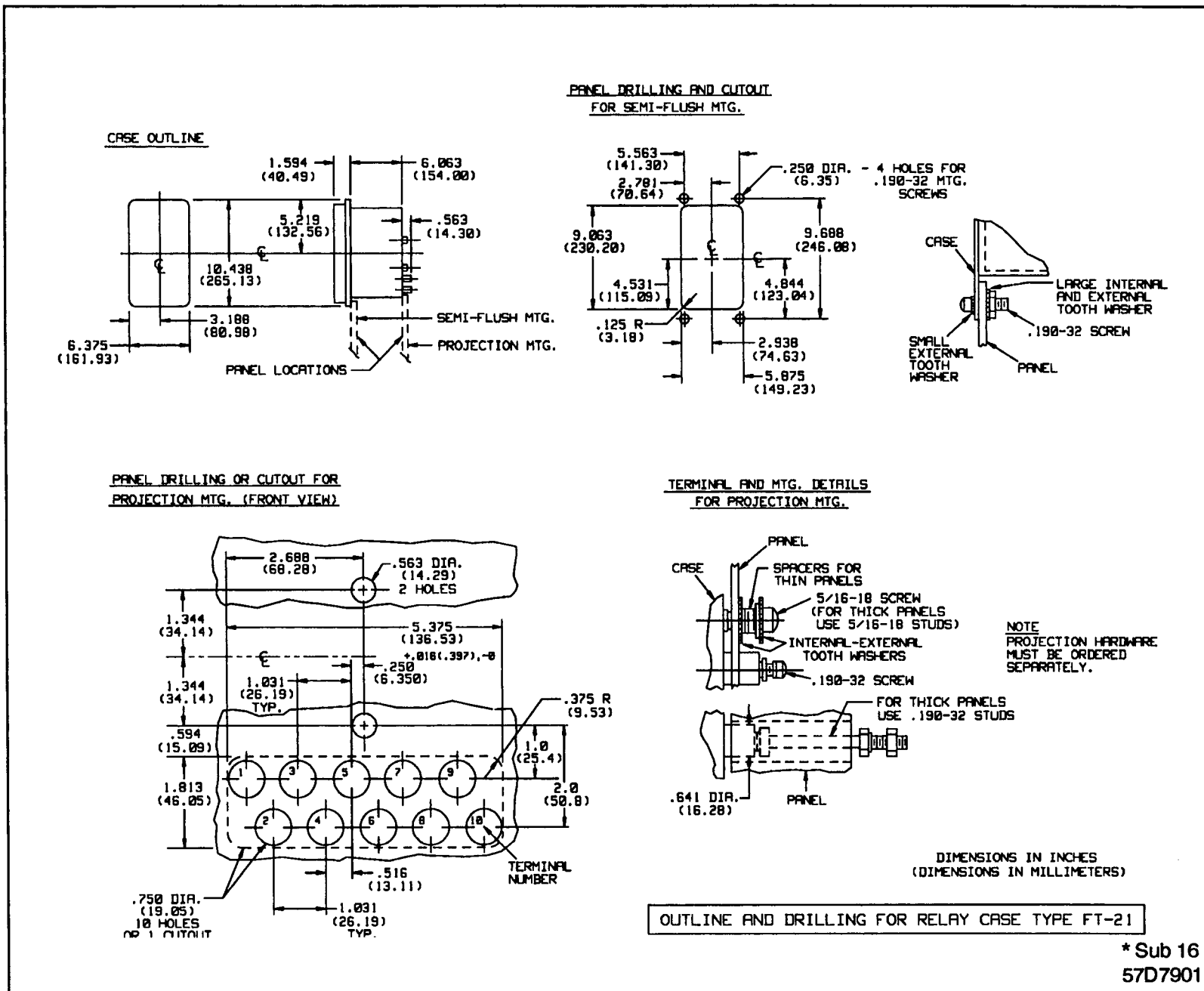

Figure 8. Outline and Drilling Plan for the Type CW Relay in the Type FT 21 Case.

* Denotes Change