

Rev. 10/75

Westinghouse I.L. 41-491.4N

INSTALLATION • OPERATION • MAINTENANCE I N S T R U C T I O N S

Type KD-4 and KD-41 COMPENSATOR DISTANCE RELAY (.75-20 Ohms)

CAUTION: Before putting protective relays into service make sure that all moving parts operate freely, inspect the contacts to see that they are clean and operate the relay to check the settings and electrical connections.

APPLICATION

The type KD-4 relay (Figure 1), is a polyphase compensator type relay which provides a single zone of phase protection for all three phases. It provides * essentially instantaneous tripping for phase-to-phase faults, two-phase-to-ground faults, and three-phase faults within the reach setting and sensitivity level of the relay. The relay is interchangeable with KD or KD-1 relays.

The type KD-41 relay, (Figure 1), is similar to the KD-4 relay except that its characteristic impedance circle includes the origin. This relay is applied as a third zone of protection in pilot relaying schemes but it may also be used for time delay tripping in straight distance relaying. Both KD-4 and KD-41 relays are available with indicating contactor switches with either a 1 ampere or a 0.2/2.0 ampere rating. The 1 ampere rating is recommended for all directional comparison applications and for most distance relaying applications. The 0.2/2.0 ampere rating is recommended for distance relaying where a lockout relay is energized or where a high impedance auxiliary tripping relay is utilized.

Refer to I.L. 41-911 for a description of how KD-4 relays are used in directional comparison blocking systems.

For time-distance applications the KD-4 and KD-41 relays are used with either the TD-2 a-c current-operated timer, or with the TD-4 or TD-5 μ -c transistorized timer. See Figs. 17 and 18 for the external schematics for 3 zone protection, using the TD-2 and TD-4 relays, respectively. For further discussion see "External Connections."

Use fault detectors to supervise the trip circuit for those applications where the relays can be de-energized without attendant opening of the 52a con-

tact. Otherwise, undesired tripping occurs. A S#1878395 three unit SC Relay (2-8 amperes) in the type FT32 case or a S#288B714A18 three unit ITH Relay (4-8 amperes) in the type FT11 case is recommended.

CONSTRUCTION

The type KD-4 relay consists of three single air gap transformers (compensators), three tapped auto-transformers, two cylinder type operating units, and an ICS indicating contactor switch.

Compensator

The compensators which are designated T_{AB} and T_{BC} are three-winding air-gap transformers (Fig.2). There are two primary current windings, each current winding having seven taps which terminate at the tap block. (Fig. 3). They are marked 0.87, 1.16, 1.45, 2.03, 2.9, 4.06 and 5.8. Current flowing through the primary coil provides an MMF which produces magnetic lines of flux in the core. Compensator, designated T, has only one primary winding.

A voltage is induced in the secondary which is proportional to the primary tap and current magnitude. This proportionality is established by the cross sectional area of the laminated steel core, the length of an air gap which is located in the center of the coil, and the tightness of the laminations. All of these factors which influence the secondary voltage proportionality have been precisely set at the factory. The clamps which hold the laminations should not be disturbed by either tightening or loosening the clamp screws.

The secondary winding has a single tap which divides the winding into two sections. One section is connected subtractively in series with the relay terminal voltage. Thus a voltage which is proportional to the phase current is subtracted vectorially from the relay terminal voltage. The second section is connected to an adjustable loading resistor and provides a means of adjusting the phase angle relation between primary current and the induced secondary

SUPERSEDES I.L. 41-491.4M, dated April 1973

*Denotes change from superseded issue.

EFFECTIVE AUGUST 1975

TYPE KD-4 & KD-41 RELAYS

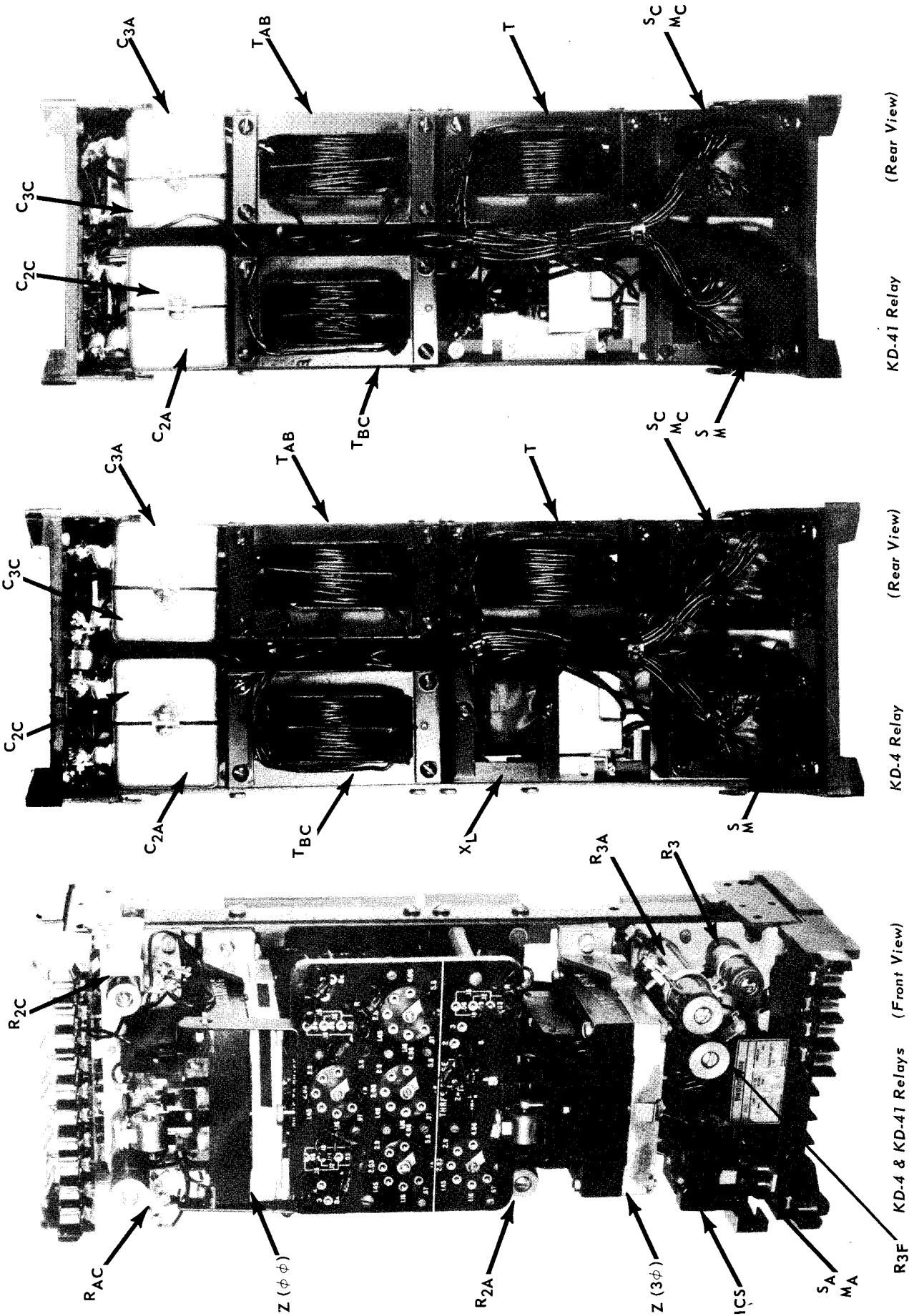

(Rear View)

KD-41 Relay

(Rear View)

KD-4 Relay

(Front View)

KD-4 & KD-41 Relays

Fig. 1 Type KD-4 and KD-41 Relays without case.

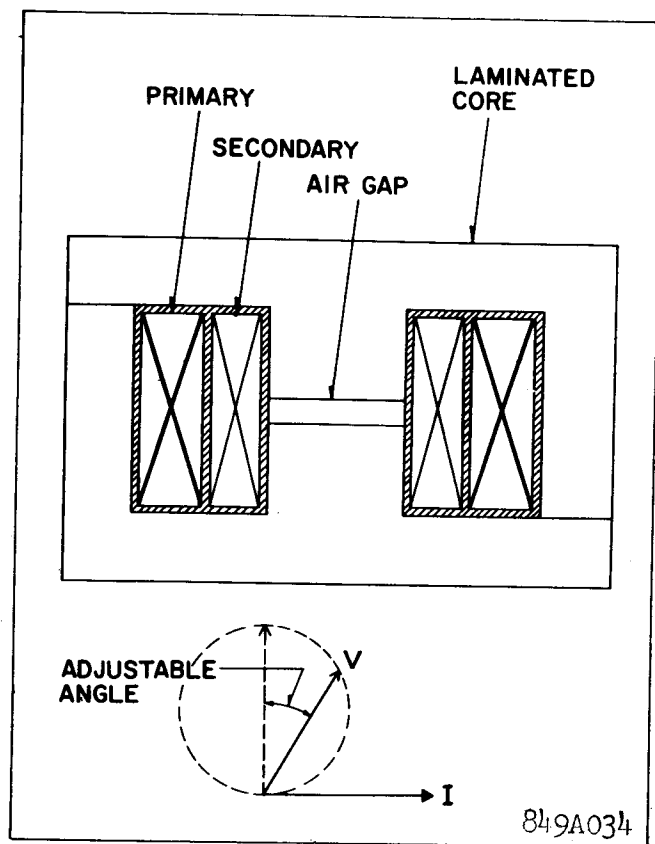

Fig. 2 Compensator Construction

voltage. The phase angle may be set for any value between 60° and 80° by adjusting the resistor between its minimum and maximum value respectively or for 89° by open circuiting the resistor. The factory setting is for a maximum torque angle of 75° current lagging voltage.

Auto - Transformer

The auto-transformer has three taps on its main winding, S, which are numbered 1, 2 and 3 on the tap block. A tertiary winding M has four taps which may be connected additively or subtractively to inversely modify the S setting by any value from -18 to $+18$ percent in steps of 3 percent.

The sign of M is negative when the R lead is above the L lead. M is positive when L is in a tap location which is above the tap location of the R lead. The M setting is determined by the sum of per-unit values between the R and L lead. The actual per unit values which appear on the tap plate between taps are 0, .03, .09 and .06.

The auto-transformer makes it possible to expand

the basic range ($T = .87$ to 5.8) ohms by a multiplier of $\frac{S}{1 \pm M}$. Therefore, any relay ohm setting can be

made within ± 1.5 percent from 0.73 ohms to 21.2 ohms by combining the compensator taps T, T_{AB} , and T_{BC} with the auto-transformer taps S and M, S_A and M_A , and S_C and M_C .

Tripping Unit

The device which acts to initiate tripping is a four-pole cylinder unit which is connected open delta and operates as a three-phase induction motor. Contact-closing torque is produced by the unit when the voltage applied to its terminals has a negative-phase sequence. Closing torque for the relay forces the moving contact to the left hand side as viewed from the front of the relay. Contact-opening torque is produced when positive-phase sequence voltages are applied. Hence, the cylinder unit has restraint or operating torque as determined by the phase sequence of the voltages applied to its terminals.

Mechanically, the cylinder unit is composed of three basic components: a die-cast aluminum frame and electromagnet, a moving element assembly, and a molded bridge.

The frame serves as the mounting structure for the magnetic core. The magnetic core which houses the lower pin bearing is secured to the frame by a spring and snap ring. This is an adjustable core which has a .020 inch flat on one side and is held in its adjusted position by the clamping action of two compressed springs. The bearing can be replaced, if necessary, without having to remove the magnetic core from the frame.

The electromagnet has two series-connected coils mounted diametrically opposite one another to excite each set of poles. Locating pins on the electromagnet are used to accurately position the lower pin bearing, which is mounted on the frame, with respect to the upper pin bearing, which is threaded into the bridge. The electromagnet is permanently secured to the frame and can not be separated from the frame.

The moving element assembly consists of a spiral spring, contact carrying member, and an aluminum cylinder assembled to a molded hub which holds the shaft. The hub to which the moving-contact arm is clamped has a wedge-and-cam construction, to provide low-bounce contact action. A casual inspection of the assembly might lead one to think that the

TYPE KD-4 & KD-41 RELAYS

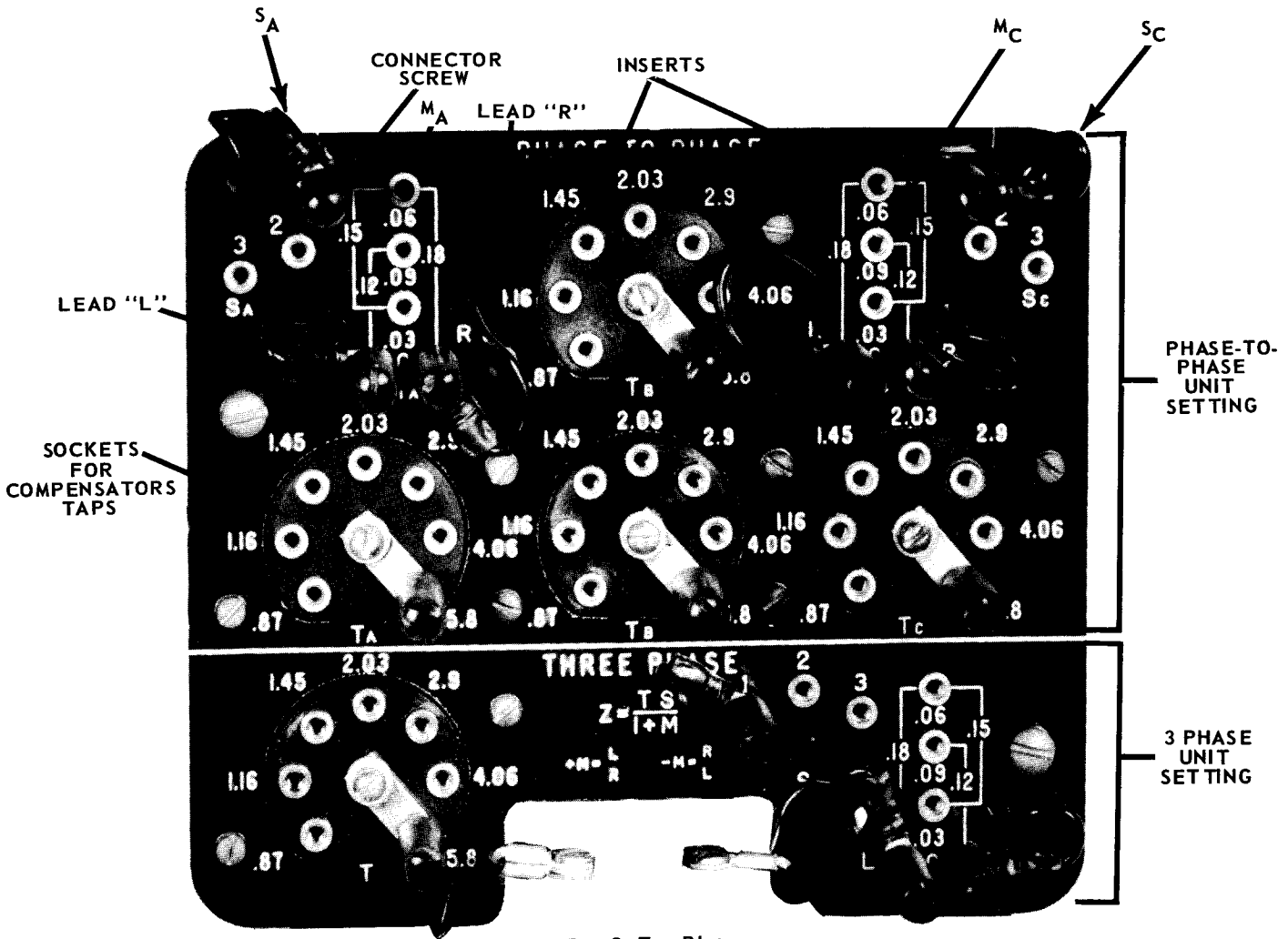

Fig. 3 Tap Plate

contact arm bracket does not clamp on the hub as tightly as it should. However, this adjustment is accurately made at the factory and is locked in place with a lock nut and should not be changed.

Optimum contact action is obtained when a force of 7 to 9 grams pressure applied to the face of the moving contact will make the arm slip one-fourth of its total free travel. Free travel is the angle through which the hub will slip from the condition of reset to the point where the clamp projection begins to ride up on the wedge. The free travel can vary between 15° to 20°.

The shaft has removable top and bottom jewel bearings. The shaft rides between the bottom pin bearing and the upper pin bearing which is adjusted to .025 inch from the top of the shaft bearing. The cylinder rotates in an air formed by the electromagnet and the magnetic core.

The bridge is secured to the electromagnet and the frame by two mounting screws. In addition to holding the upper pin bearing, the bridge is used for mounting the adjustable stationary contact housing.

This stationary contact has .002 to .006 inch follow which is set at the factory by means of the adjusting screw. After the adjustment is made the screw is sealed in position with a material which flows around the threads and then solidifies. The stationary contact housing is held in position by a spring type clamp. The spring adjuster is located on the underside of the bridge and is attached to the moving contact arm by a spiral spring. The spring adjuster is also held in place by a spring type clamp.

The main contact of KD4 and KD41 relays will close 30 amp. at 250 V d.c. and the seal-in contact of the indicating contactor switch will carry this current long enough to trip a breaker.

When the contacts close, the electrical connection is made through the stationary contact housing clamp, to the moving contact, through the spiral spring and out to the spring adjuster clamp.

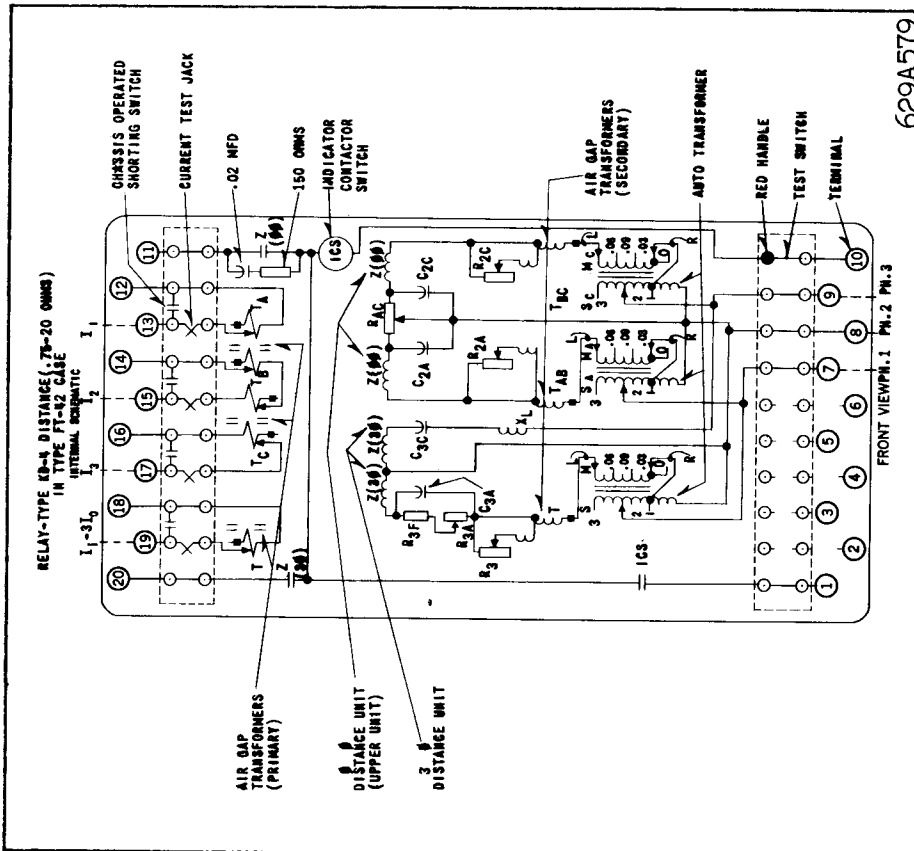

Fig. 4 Internal Schematic of Type KD-4 Relay with 1.0 ampere I.C.S. in Type FT42 case. (Relay with 0.2/2.0 ampere I.C.S. unit has identical wiring except that the I.C.S. coil is tapped on terminal 10, 629A578).

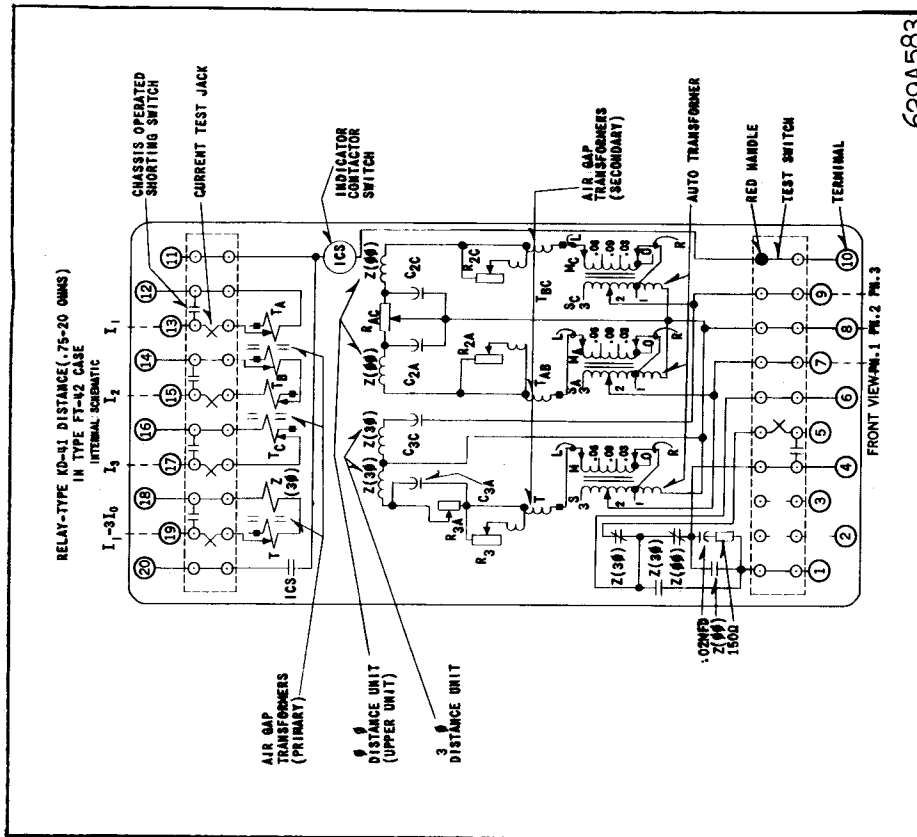

Fig. 5 Internal Schematic of Type KD-41 Relay with 1.0 ampere I.C.S. in Type FT42 case. (Relay with 0.2/2.0 ampere I.C.S. unit has identical wiring except that the I.C.S. coil is tapped on terminal 10, 629A582).

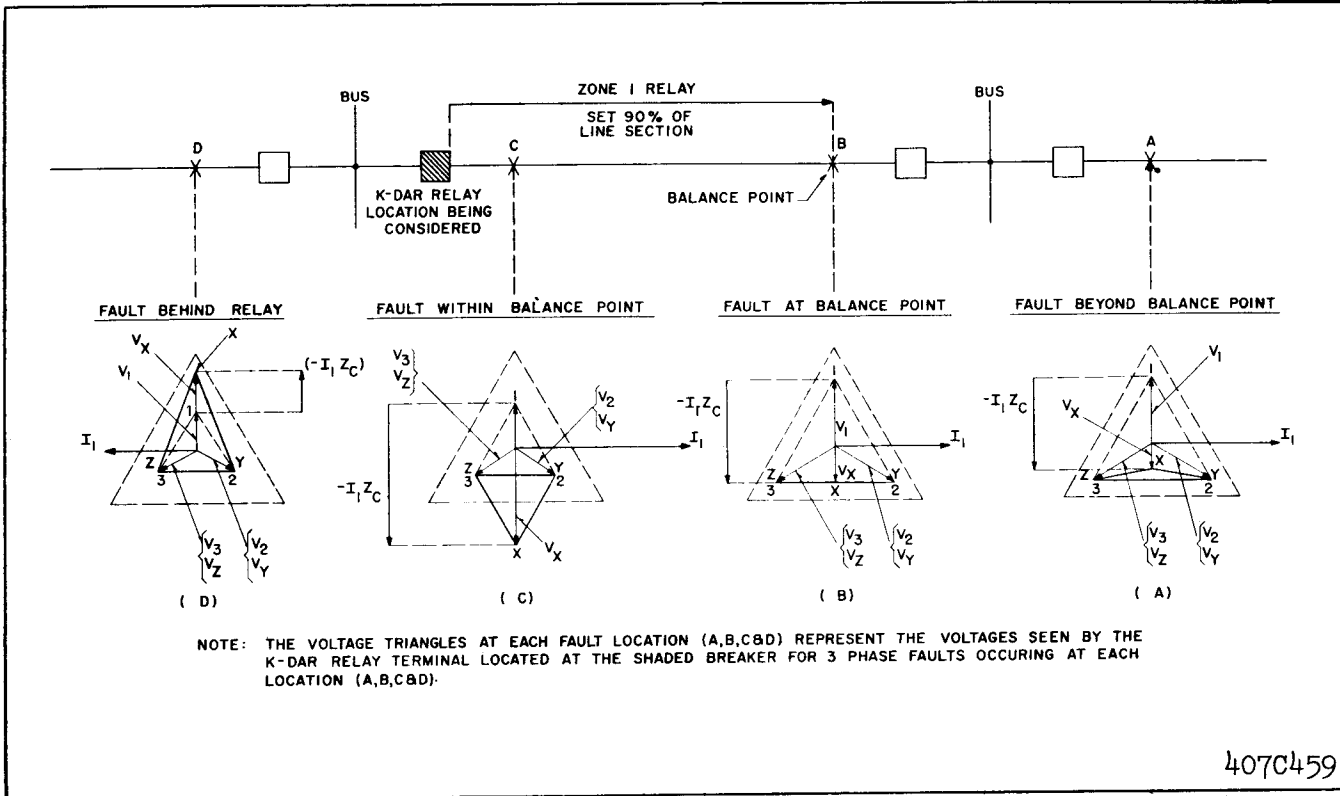

Fig. 6 Voltage and current conditions for the Three-Phase Unit at the Shaded Breaker for Three-Phase Faults at various Locations.

Indicating Contactor Switch Unit (ICS)

The indicating contactor switch is a small d-c operated clapper type device. A magnetic armature, to which leaf-spring mounted contacts are attached, is attracted to the magnetic core upon energization of the switch. When the switch closes, the moving contacts bridge two stationary contacts, completing the trip circuit. Also during this operation two fingers on the armature deflect a spring located on the front of the switch, which allows the operation indicator target to drop. The target is reset from outside of the case by a push rod located at the bottom of the cover.

The front spring, in addition to holding the target, provides restraint for the armature and thus controls the pickup value of the switch.

OPERATION

The KD-4 relay has two major components-compensators and tripping units. In the internal schematic of Fig. 4 the compensators are designated T, T_{AB}, and T_{BC}, the tripping units, Z (3φ) & Z (φφ). The phase-to-phase unit, Z (φφ), operates for all combinations of phase-to-phase faults (phase 1-2, 2-3 & 3-1). The 3 phase unit Z (3φ) operates for 3 phase faults and for close-in-two-phase-to-ground faults, although

most two-phase-to-ground faults are cleared by operation of the phase-to-phase unit. Each of the tripping units and its associated compensator circuit are electrically separate, and will now be considered successively.

Three Phase Unit

A single compensator T has its primary energized with $(I_1 - 3I_0)$ current in Fig. 17. Current I_1 is the phase 1 current; $3I_0$ is the residual current. There are three compensators shown — one for each of the three zones. One connection uses an auxiliary current transformer to insert the $3I_0$ component. The alternate connection supplies the compensator primaries with $(-I_2 - I_3)$. Since $I_1 + I_2 + I_3 = 3I_0$, $(I_1 - 3I_0) = (-I_2 - I_3)$. (Currents I_1 , I_2 and I_3 are the phase currents.)

Accordingly, the alternate connection is equivalent to the first arrangement. Note that relay 21-3, a type KD-41, also has a current winding Z. This winding is wound on the tripping unit so that the R-X diagram circle includes the origin, as explained under "Characteristics."

As shown in Fig. 17, the T compensator second-

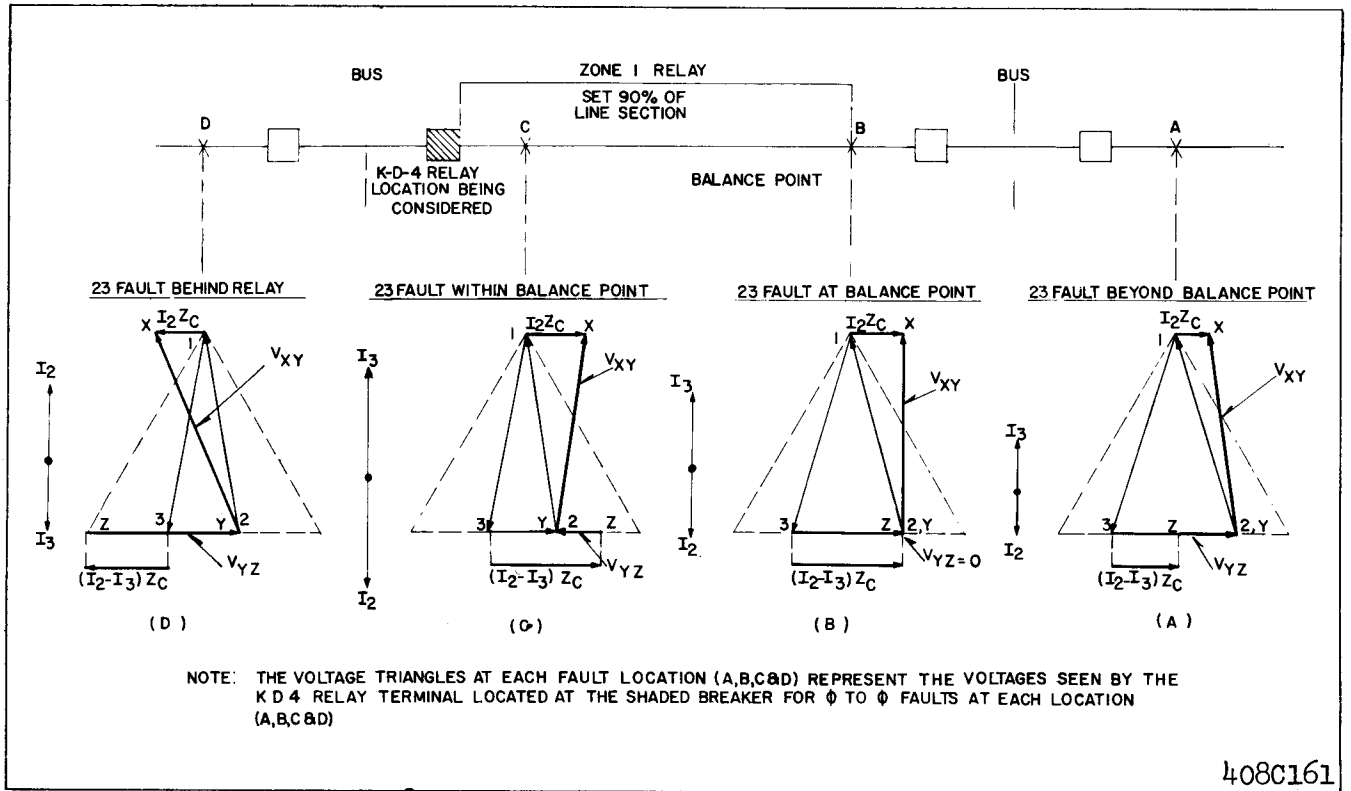

Fig. 7 Voltage and current conditions for the Phase-to-Phase Unit at the Shaded Breaker for 2-3 Faults at Various Locations.

ary is connected to modify the phase 1 voltage. With a fault in the trip direction, the induced voltage in the compensator secondary bucks the phase 1 voltage.

Vector diagrams in Fig. 6 illustrate the operation during 3 phase faults at four locations. The system impedance and the compensator angle are assumed to be at 90° for illustrative purposes only. Prefault voltages are depicted by the large triangle. The small dashed triangle in each case is the system voltages at the relay location during the fault. This triangle is modified by the compensator voltage, $-I_1 Z_C$, where Z_C is the compensator mutual impedance. The terminals of the tripping unit are designated: X, Y & Z. Phase 1 tripping unit voltage is:

$$V_X = V_1 - I_1 Z_C$$

Where

$$V_1 = 1.5 V_{10}$$

Phase 2 and phase 3 tripping unit voltages are:

$$V_Y = V_2$$

$$V_Z = V_3$$

For a fault at A, beyond the relay operating zone, the compensator voltage, $-I_1 Z_C$, modifies the phase

1 voltage, reducing the voltage triangle on the tripping unit to X-Y-Z. With an X-Y-Z rotation the tripping unit torque is in the restraining direction.

For a fault at B, the current is larger than for a fault at A, so that $-I_1 Z_C$ is larger. The point X is in line with points Y & Z. No torque is produced, since the X-Y-Z triangle has a zero area.

For a fault in the operating zone, such as at C, point X is below the YZ line. Now the rotation is X-Z-Y, which produces operating torque.

For a fault behind the relay at D, restraining torque is produced. Since the fault is behind the relay the current is of reversed polarity. Compensator voltage, $-I_1 Z_C$, increases the area of the bus voltage triangle, 1-2-3. Tripping unit voltage has an X-Y-Z rotation which produces restraining torque.

A solid 3 phase fault at the relay location, tends to completely collapse the 1-2-3 voltage triangle. The area of the X-Y-Z triangle also tends to be zero under these conditions. A memory circuit in the KD-4 relay provides momentary operating torque under these conditions, for an internal fault. In the KD-41 relay the coil Z in the current circuit, in conjunction with the compensator voltage, produces a current

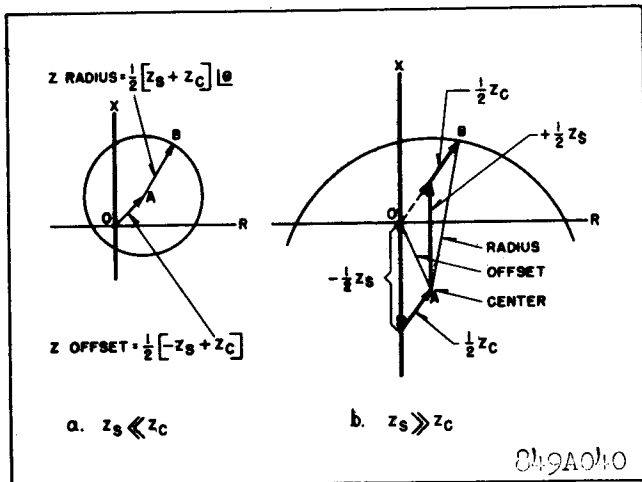

Fig. 8 Impedance Circles for Phase-to-Phase Unit in the Type KD-4 and KD-41 Relay.

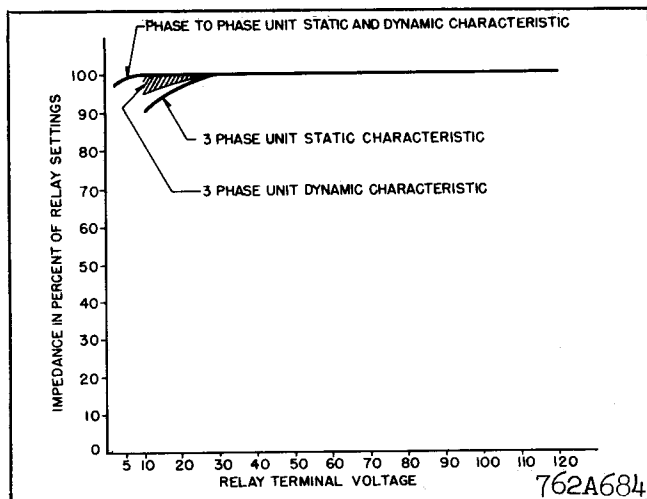

Fig. 9 Impedance Curves for Type KD-4 and KD-41 Relays.

only torque, which maintains operating torque under the condition of zero potential.

The $R_{3A} - R_{3F}$ and C_{3A} parallel resistor-capacitor combination in the compensated phase corrects for a shift in the phase-angle relation between the voltage across the left hand coils of $Z (3\phi)$ and the voltage across the right hand coils of $Z (3\phi)$, in figures 4 & 5. This phase shift is produced by capacitor C_{3C} . The $R_{3AF} - C_{3A}$ combination also provides control of transients in the inductive coils of the cylinder unit.

Phase-to-Phase Unit

Compensator primaries of T_{AB} and T_{BC} are energized by I_1, I_2 and I_3 , as shown in Fig. 17. Compensator secondaries are connected to modify their respective phase voltages (e.g., T_{AB} modifies V_{12}). With a fault in the trip direction, the induced voltages in the compensator secondaries buck the phase-phase voltages.

Vector diagrams in Fig. 7 illustrate the operation during phase 2-3 faults at four locations. The system impedances and the compensator angle are assumed to be at 90° , for illustrative purposes. Prefault voltages are depicted by the large triangles. The smaller light triangle in each case is the system voltages at the relay location during the fault. This triangle is modified by the compensator voltages $(I_1 - I_2) Z_C$ and $(I_2 - I_3) Z_C$ where Z_C is the compensator mutual impedance. In this case $I_1 = 0$. The terminals of the tripping unit are designated; X, Y and Z. Tripping unit voltages are for phase 2-3 fault:

$$V_{XY} = V_{12} - (I_1 - I_2) Z_C$$

Phase 2-3 tripping unit voltage is:

$$V_{YZ} = V_{23} - (I_2 - I_3) Z_C$$

For a fault at A, in Fig. 7, beyond the relay operating zone, the compensator voltages change the 1-2-3 voltage sequence to the X-Y-Z sequence. Voltages of this sequence applied to operating unit produce restraining torque.

For a fault at B, the currents are larger than for a fault at A, so that compensator voltages are larger. Points Y & Z coincide now and the area of the X-Y-Z triangle is zero. No torque is produced.

For a fault in the operating zone, such as at C, the compensator voltages reverse the rotation of tripping unit voltages to X-Z-Y sequence. Voltages of this sequence applied to operating unit produce operating torque.

For a fault behind the relay at D, restraining torque is produced. Since the fault is behind the relay, the current is of reversed polarity and tripping unit voltage has an X-Y-Z rotation. This rotation produces restraining torque.

Note that this unit does not require memory action, since the sound-phase voltage reacts with the compensator voltages to produce a strong restraining or a strong operating torque, depending upon the fault location. This is true even for a complete collapse of the faulted phase-to-phase voltage. The phase-to-phase unit is identical in the KD-4 and KD-41 relays.

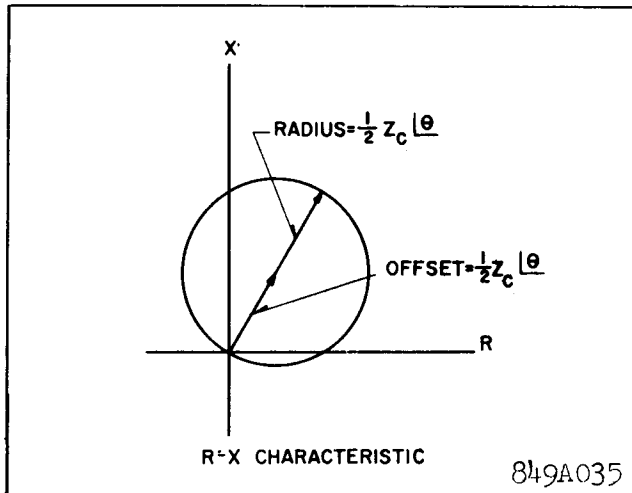

Fig. 10 Impedance Circle for Three-Phase Unit in Type KD-4 Relay.

Similar vector diagrams apply for a fault between phases 1 & 2 or between phases 3 & 1. Each of the three phase-to-phase fault combinations subjects the cylinder unit to a similar set of conditions.

CHARACTERISTICS

Distance Characteristic – Phase-to-Phase Unit

This unit responds to all phase-to-phase faults and most two-phase-to-ground faults. It does not respond to load current, synchronizing surges, or out-of-step conditions. While a characteristic circle can be plotted for this unit on the RX diagram as shown in Fig. 8, such a characteristic circle has no significance except in the first quadrant where resistance and reactance values are positive. A small portion of the fourth quadrant, involving positive resistance values and negative reactance values, could have some significance in the event that the transmission line includes a series capacitor. The portion of the circle in the first quadrant is of interest because it describes what the relay will do when arc resistance is involved in the fault. The phase-to-phase unit operating on an actual transmission system is inherently directional and no separate directional unit is required.

An inspection of Fig. 8 indicates that the circle of the phase-to-phase unit is dependent on source impedance Z_S . However, the circle always goes through the line balance point impedance. The reach at the compensator (and line) angle is constant, regardless of the system source impedance. The broadening out of the characteristic circle with a relatively

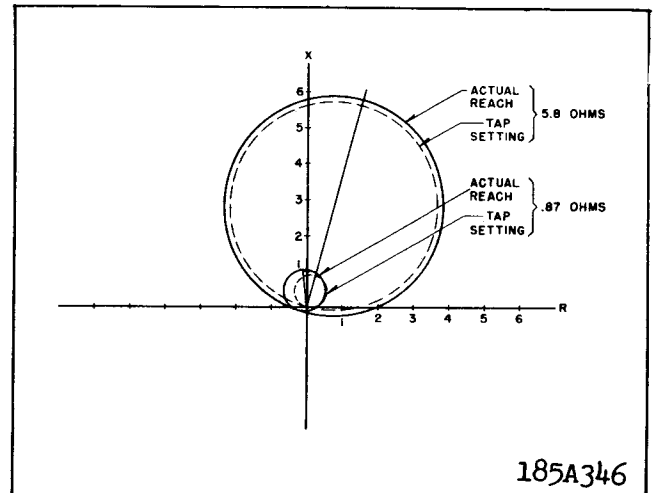

Fig. 11 Impedance Circle for Three-Phase Unit in Type KD-41 Relay.

high source impedance gives the phase-to-phase unit the advantageous characteristic that for short lines, it makes a greater allowance for resistance in the fault. Stated another way, the characteristics approach that of a reactance relay more and more closely as the line being protected becomes shorter and shorter with respect to the source impedance back of the relaying location.

Sensitivity: Phase-to-Phase Unit

A plot of relay reach, in percent of tap block setting, versus relay terminal voltage is shown in Figure 9. The unit will operate with the correct directional sense for zero voltage phase-to-phase faults. For this condition the fault current must be not less than 0.015 relay amperes with an ohm setting of 5.8 with rated voltage on the unfaulted phase. Pick up current is proportionately higher in $S = 2$ and $S = 3$ taps.

The KD-4 relay may be set without regard to possible overreach due to d-c transients. Compensators basically are insensitive to d-c transients which attend faults on high-angle systems. The long time-constant of a high-angle system provides a minimum rate of change in flux-producing transient current with respect to time, and therefore induces a minimum of uni-directional voltage in the secondary. Asymmetrical currents resulting from faults on low-angle systems having a short time constant can induce considerable voltage in the secondary, but for the first half cycle, the transient-derived voltage subtracts from the steady-state value. This transient decays so rapidly that it is insignificant during the second half cycle when it adds to the steady-state value.

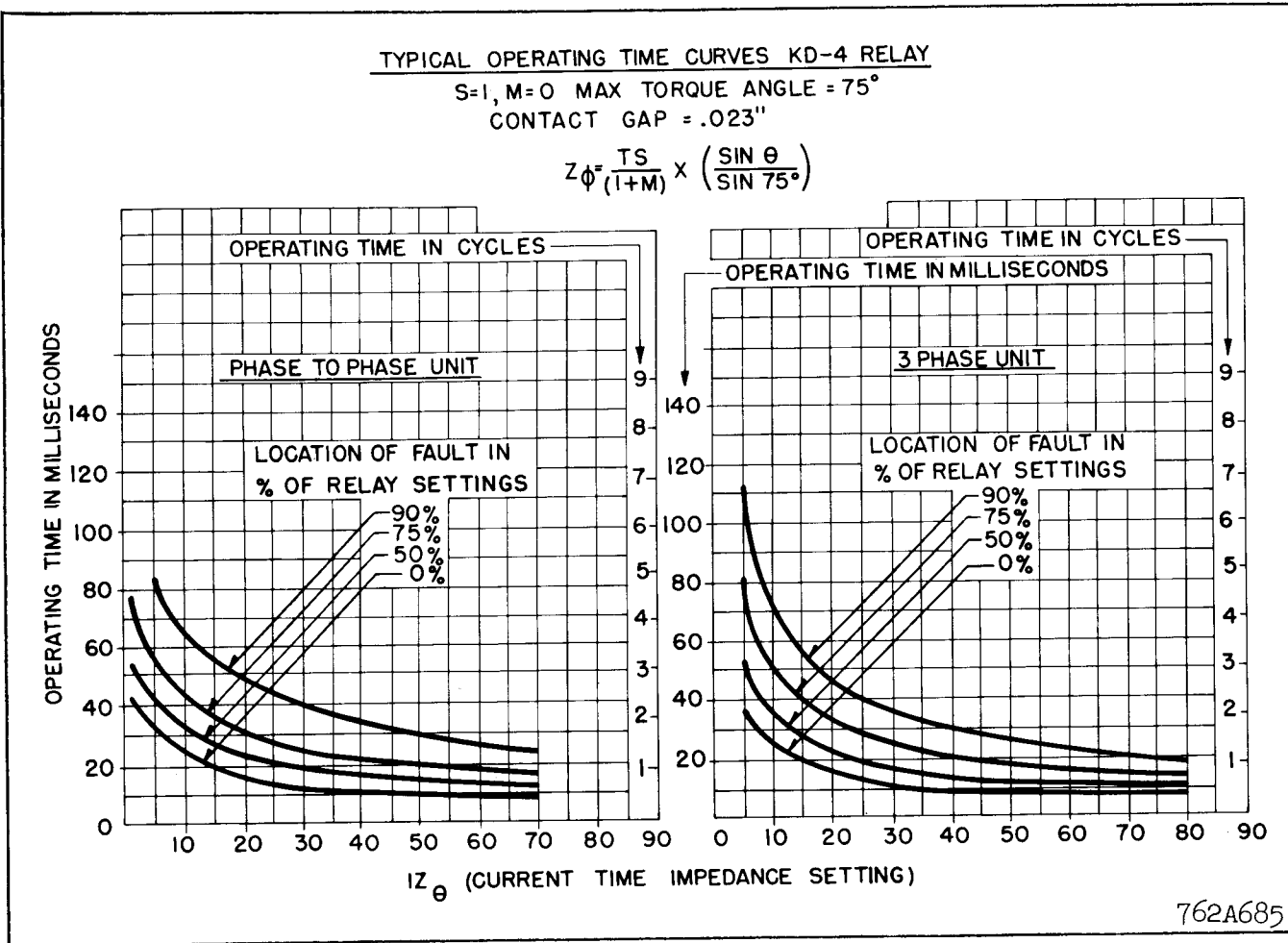

Fig. 12 Typical Operating Time Curves of Type KD-4 Relay. Normal voltage before the fault is 120 volts.

Distance Characteristic – KD-4, 3 Phase Unit

The three-phase unit has a characteristic circle which passes through the origin as shown in Figure 10. This circle is independent of source impedance. The three-phase unit is also inherently directional and does not require a separate directional unit.

If a solid-three phase fault occurs right at the relay location, the entire voltage triangle collapses to zero to give a balance point condition, as shown by the relay characteristic (in Figure 10) which passes through the origin. However, since the YZ voltage also drops to zero, the relay would be unable to determine whether an internal or external fault existed. To correct this condition, a resonant circuit is added to the 2-3 voltage circuit of the relay which

allows the YZ voltage to collapse gradually, thus giving a reference voltage to determine whether the fault is inside the protected line section or behind the relay.

Sensitivity – KD-4, 3 Phase Unit

The impedance curve for the KD-4 three-phase unit is shown in Figure 10.

The unit will operate with the correct directional sense for zero voltage three-phase faults when normal voltage exists at the relay terminals prior to the fault. This operation occurs due to memory action as described above. The unit will have zero torque or perhaps a slight opening torque if there is zero voltage at the relay prior to the fault or after the memory action has subsided. With an impedance setting of 5.8 ohms the three-phase unit will direction-

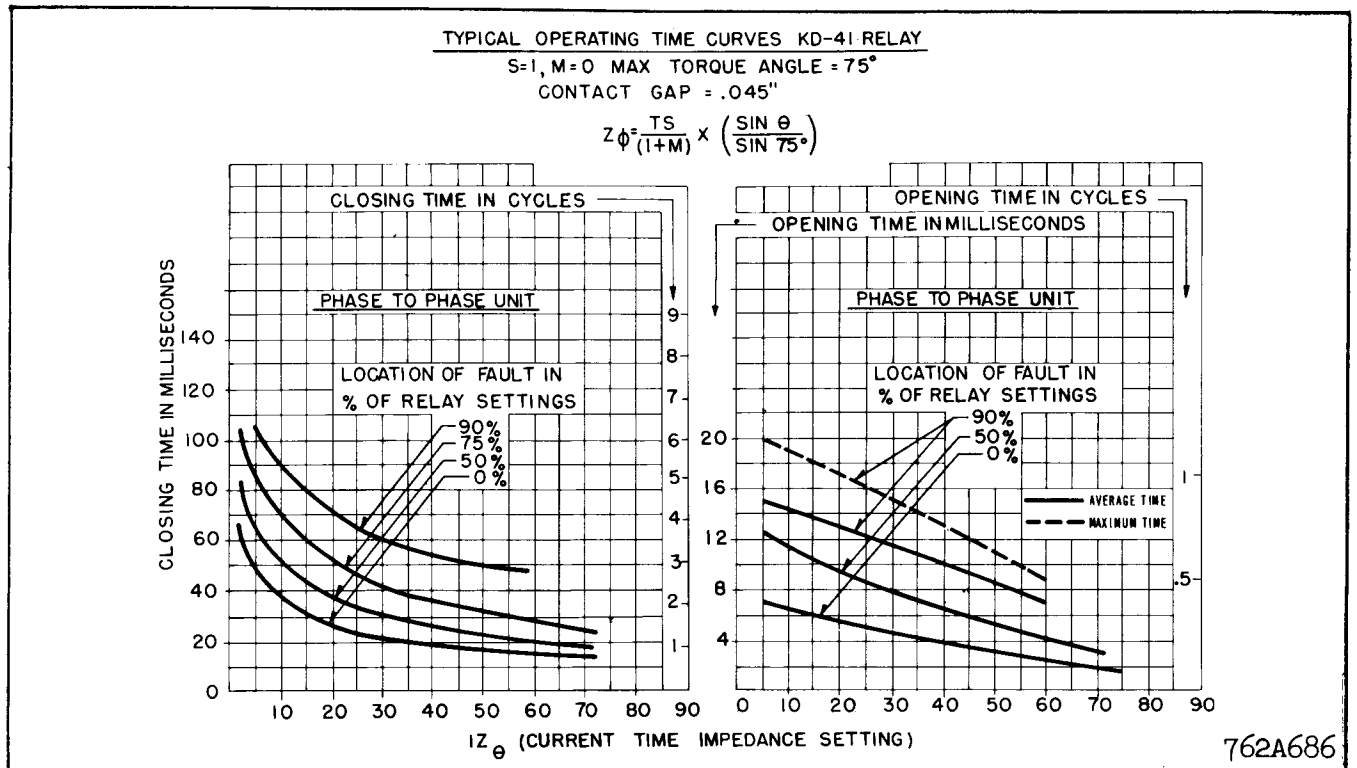

Fig. 13 Typical Operating Time Curves of Type KD-41 Relay Phase-to-Phase Unit.

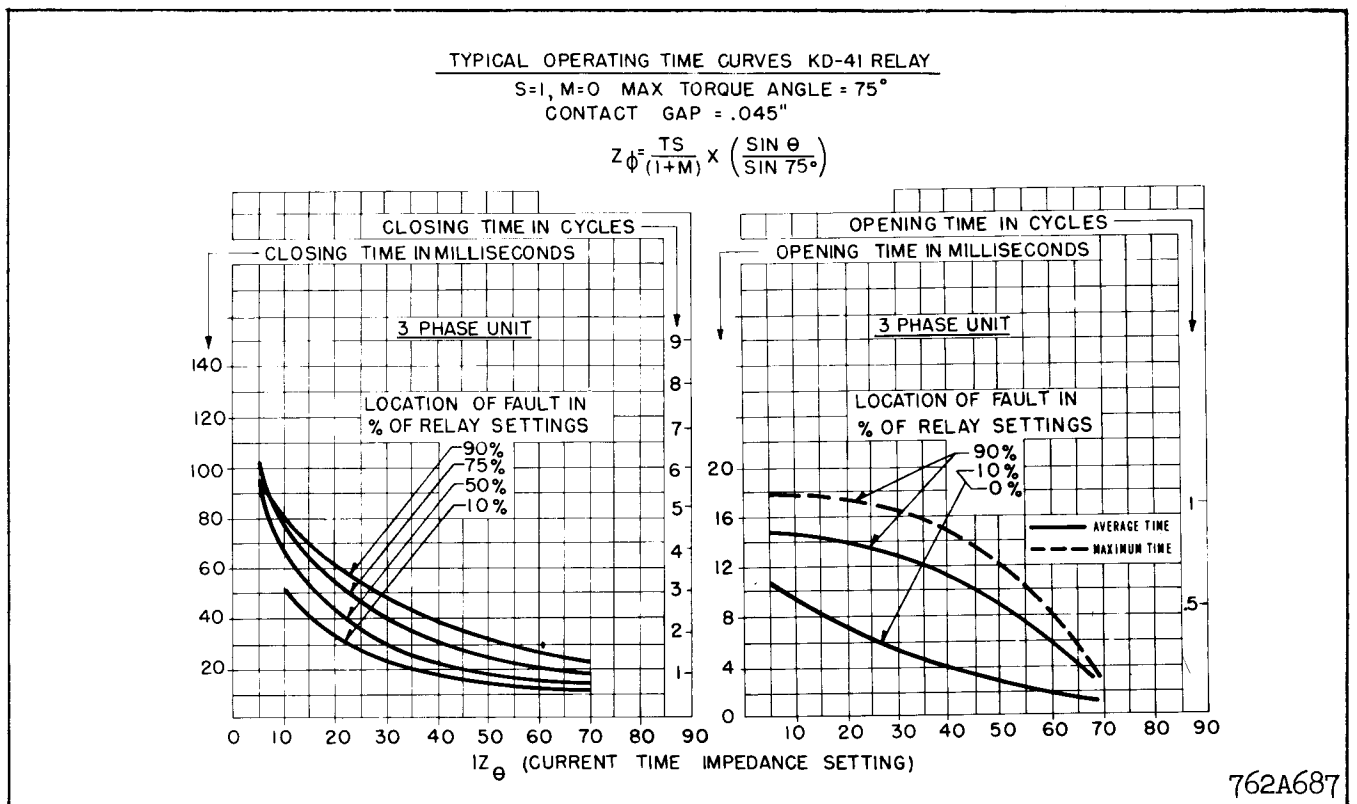

Fig. 14 Typical Operating Time Curves of Type KD-41 Relay Three-Phase-Unit.

TYPE KD-4 & KD-41 RELAYS

ally operate for faults which produce 2 volts line to line and 1.0 ampere at the relay terminals.

Sensitivity with 2 volts line-to-line for any tap is defined by the following equation:

$$I = \frac{5.8}{T} \text{ amperes}$$

The KD-4 relay may be set without regard to possible overreach due to d-c transients.

Distance Characteristic: KD-41, 3 Phase Unit

The three-phase unit of the KD-41 relay has a characteristic circle which includes the origin as shown in Figure 11. The reverse reach of this unit varies from 0.11 ohms for a T setting of .87 to 0.13 ohms for a T setting of 5.8. The forward reach of the unit varies from 102 percent of tap value for a T setting of 5.8 and 75 degrees to 120 percent of tap value at 95 degrees for a T setting of .87. Figure 11 compares the KD-4 and KD-41 reach for identical settings. The KD-4 circles are dashed. The maximum torque angle is set for 75 degrees while T is set at 5.8.

A single turn current coil on the cylinder unit provides for current-only torque and is small compared to the many turns of the 5.8 setting of the compensator and has very little influence on the overall settings. However, as the compensator setting is reduced, the single turn current coil becomes larger by comparison and has more and more effect on the overall settings.

Sensitivity: KD-41, 3 Phase Unit

The impedance curve for the KD-41 three-phase unit is shown in Figure 9. This unit will operate to close the left hand contact on current only for 3 or more amperes relay current with T set for 5.8 and for 7.5 amperes or more with T set for .87.

General Characteristics

Impedance settings in ohms reach can be made for any value from .73 ohms to 21.2 ohms in steps of 3 percent. The maximum torque angle, which is set for 75 degrees at the factory, may be set for any value from 60 degrees to 80 degrees. A change in maximum torque angle will produce a slight change in reach for any given setting of the relay. Referring to Fig. 2 note that the compensator secondary voltage output V, is largest when V leads the primary current, I, by 90°. This 90° relationship is approached, if the compensator loading resistor (R_3 , R_{2A} , or R_{2C}) is open-circuited. The effect of the loading resistor, when connected, is to produce an internal drop in the compensator, which is out-of-phase with the induced voltage, IT , IT_{AB} or IT_{CA} . Thus the

net voltage, V, is phase-shifted to change the compensator maximum torque angle. As a result of this phase shift the magnitude of V is reduced, as shown in Fig. 2.

Tap markings in Fig. 3 are based upon a 75° compensator angle setting. If the resistors R_3 , R_{2A} , and R_{2C} are adjusted for some other maximum torque angle the nominal reach is different than indicated by the taps. The reach, Z, varies with the maximum torque angle, θ , as follows:

$$Z = \frac{TS \sin \theta}{(1 + M) \sin 75^\circ}$$

TAP PLATE MARKINGS

(T, T_A , T_B , and T_C)							
.87	1.16	1.45	2.03	2.9	4.06	5.8	
(S, S_A , S_C)							
	1	2	3				

(M, M_A , M_C)			
± Values between taps	.03	.09	.06

TIME CURVES AND BURDEN DATA

Operating Time

The speed of operation for the KD-4 relay three-phase and phase-to-phase units is shown by the time curves in Figure 12. The curves indicate the time in milliseconds required for the relay to close its contacts for tripping after the inception of a fault at any point on a line within the relay setting.

Figure 13 and Figure 14 show the KD-41 operating time of the phase-to-phase unit and the three-phase unit respectively. These curves show both contact-opening time and contact-closing time for faults within the relay setting.

Current Circuit Rating in Amperes

Tap Setting	Continuous			1 Second
	S = 1	S = 2	S = 3	
5.8	5.0	8.5	9.5	240
4.06	6.0	10.0	10.0	240
2.9	8.0	10.0	10.0	240
2.03	10.0	10.0	10.0	240
1.45	10.0	10.0	10.0	240
1.16	10.0	10.0	10.0	240
0.87	10.0	10.0	10.0	240

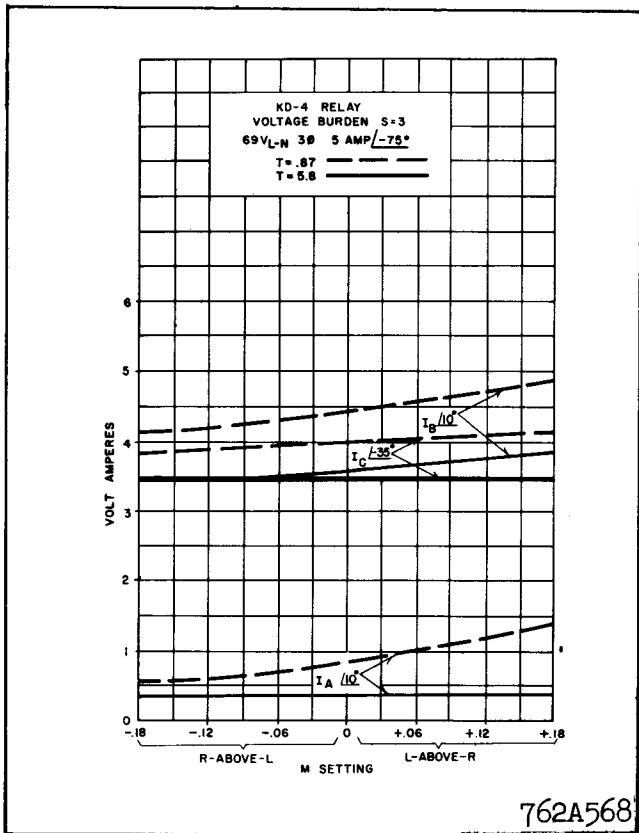
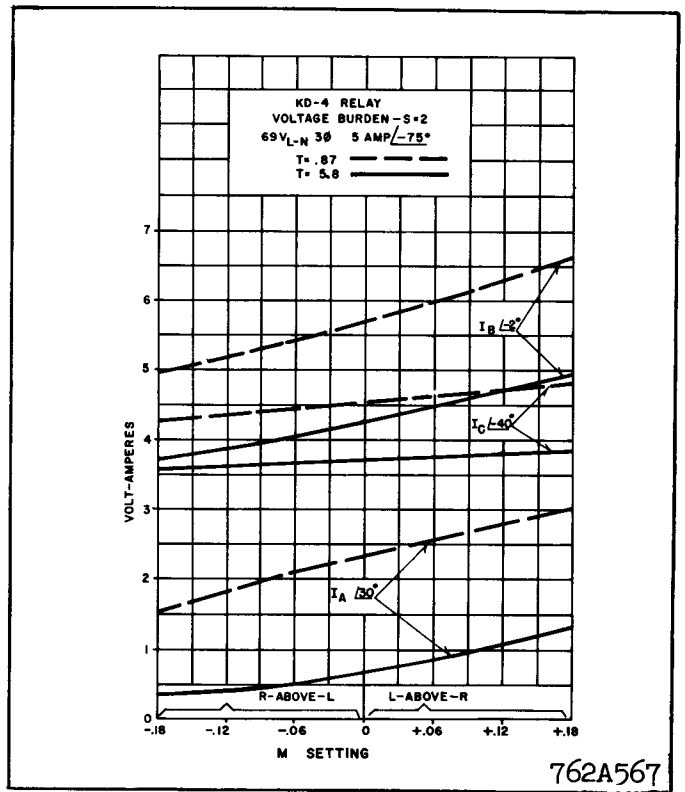
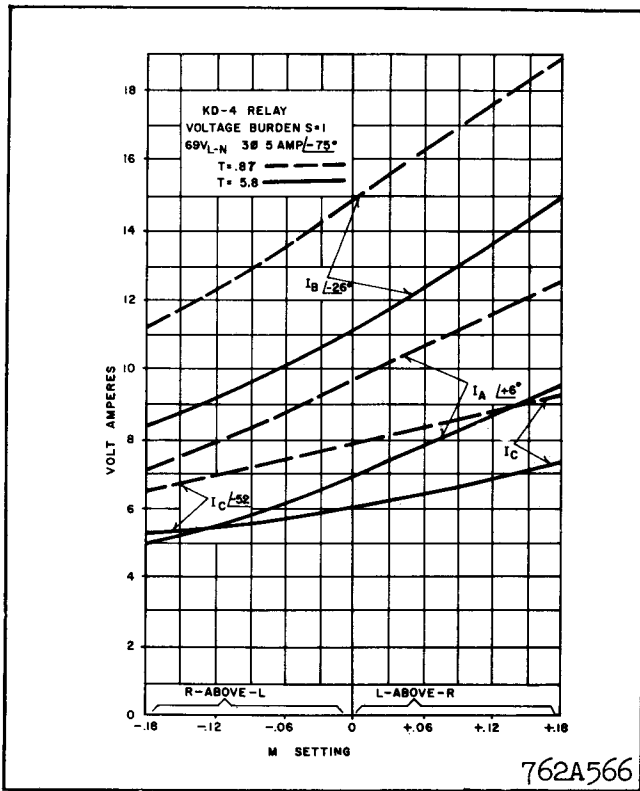

KD-4 RELAY
CURRENT BURDEN TABLE
POTENTIAL CIRCUIT 69V_{L-N} S=1
THREE PHASE CURRENT = 5 \angle -75° AMPS.

TAP SETTING	PHASE 1			PHASE 2			PHASE 3		
	VA	VARs	WATTS	VA	VARs	WATTS	VA	VARs	WATTS
.87	1.28	502	1.18	.747	.580	.471	.732	.430	.591
1.16	1.31	784	1.08	.912	.774	.483	.876	.539	.690
1.45	1.48	1,10	.994	1.08	.963	.491	.995	.640	.762
2.03	2.00	1,68	1.06	1.49	1.41	.511	1.31	.880	.978
2.90	2.87	2,82	.549	2.22	2.12	.647	1.82	1.31	1.27
4.06	4.72	4,66	.736	3.35	3.25	.811	2.58	1.95	1.69
5.80	7.70	7,59	1.20	5.41	5.25	1.31	3.97	3.13	2.44

762A569

Fig. 15 Type KD-4 Relay Burden Data

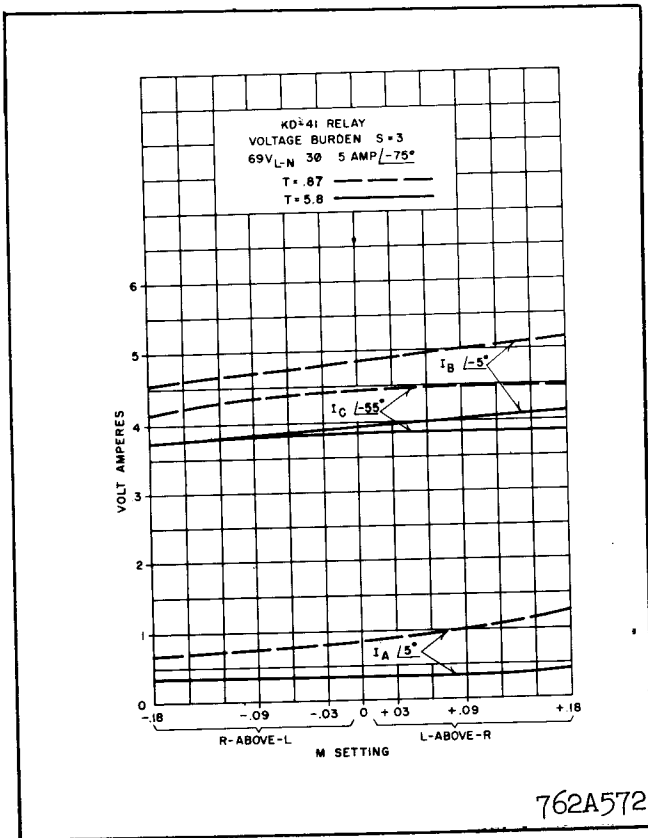
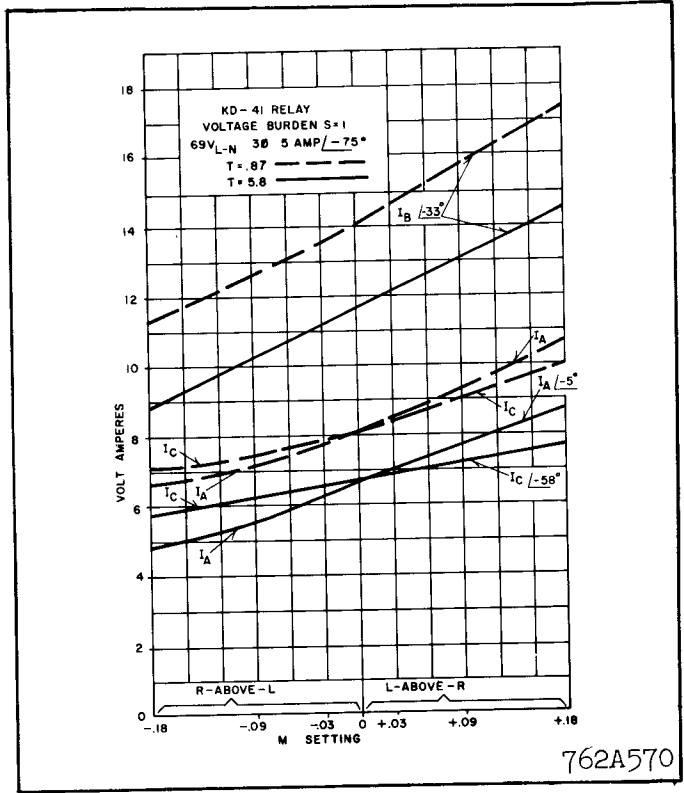
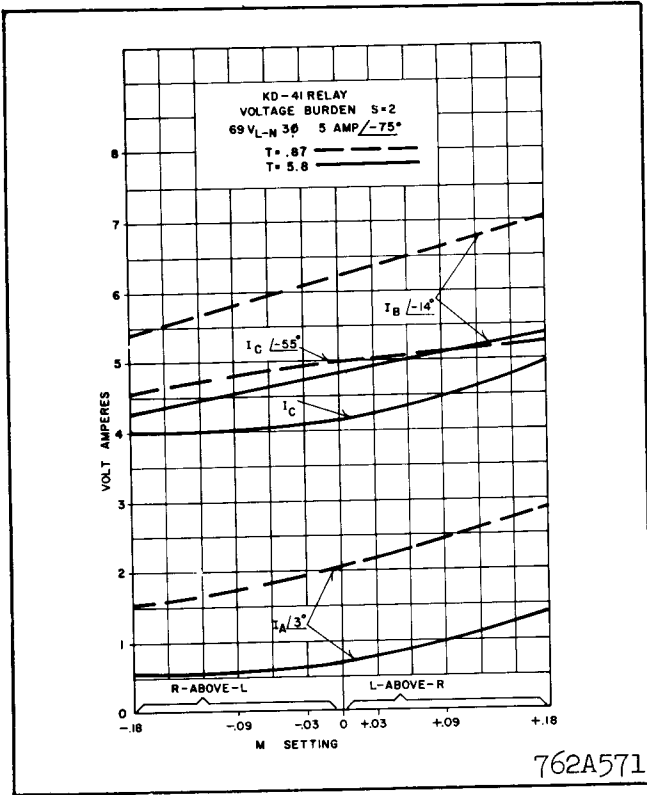

KD-41 RELAY
CURRENT BURDEN TABLE
POTENTIAL CIRCUIT 69V_{L-N} S=1
THREE PHASE CURRENT = 5/-75° AMPS.

TAP SETTING	PHASE 1			PHASE 2			PHASE 3		
	VA	VARS	WATTS	VA	VARS	WATTS	VA	VARS	WATTS
.87	1.44	.563	1.33	.882	.804	.358	.703	.540	.451
1.16	1.65	.775	1.46	1.03	1.00	.249	.833	.640	.535
1.45	1.65	1.02	1.30	1.24	1.21	.257	.885	.699	.547
2.03	2.06	1.55	1.36	1.70	1.68	.207	1.16	.983	.613
2.90	2.99	2.64	1.40	2.47	2.45	.302	1.67	1.48	.758
4.06	4.74	4.69	.578	3.66	3.62	.446	2.40	2.18	1.01
5.80	8.25	8.16	1.01	5.67	5.62	.590	3.63	3.30	1.53

762A573

Fig. 16 Type KD-41 Relay Burden Data

606B309

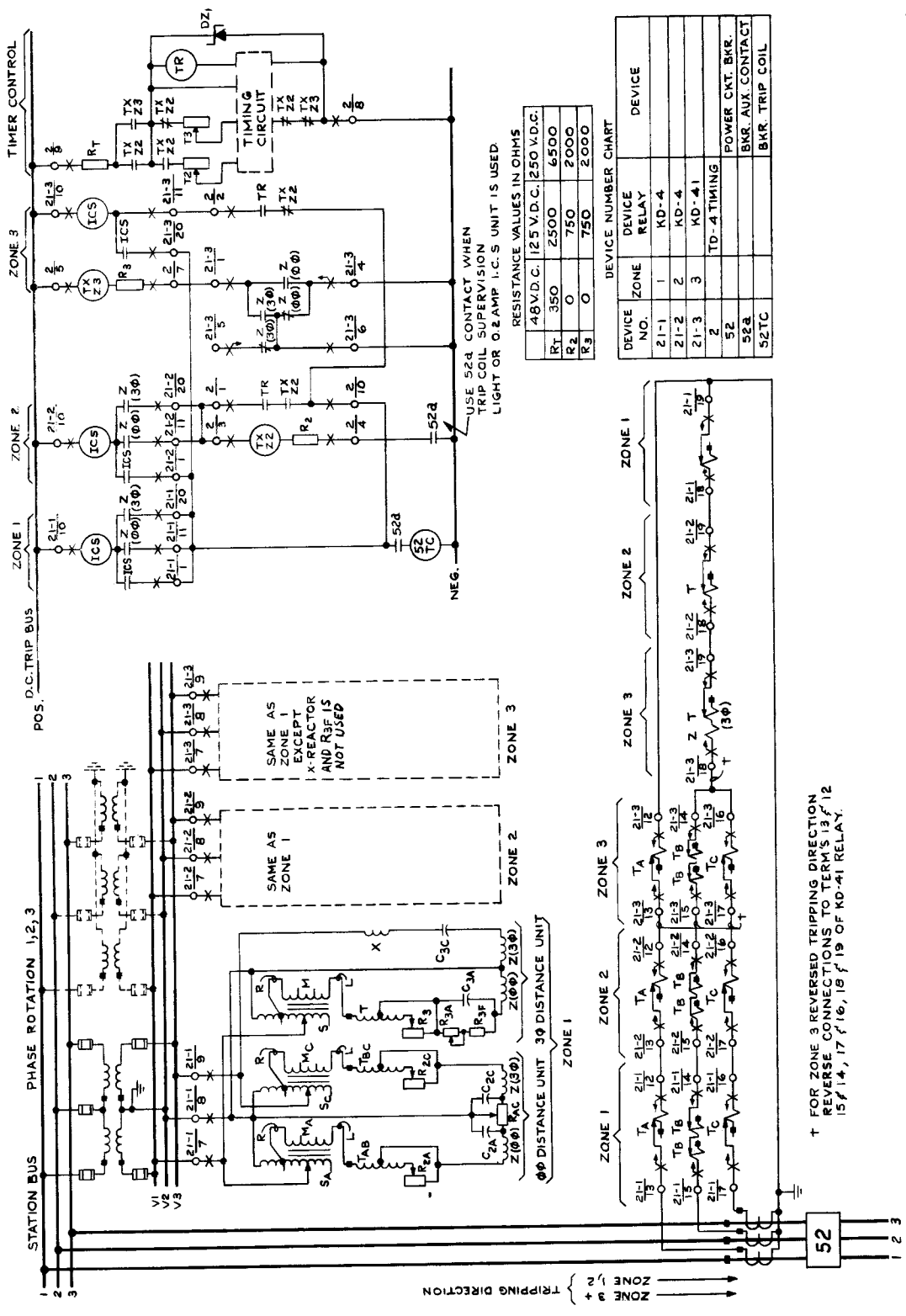

RESISTANCE VALUES IN OHMS

RT	350	2500	6500
R2	0	750	2000
R3	0	750	2000

DEVICE NUMBER CHART

DEVICE NO.	ZONE	RELAY	DEVICE
21-1	1	KD-4	
21-2	2	KD-4	
21-3	3	KD-41	
52		TD-4 TIMING	POWER CKT. BKR.
52B			BKR. AUX. CONTACT
52TC			BKR. TRIP COIL

USE 52B CONTACT WHEN TRIP COIL SUPERVISION LIGHT OR 0.2 AMP I.C.S UNIT IS USED

† FOR ZONE 3 REVERSED TRIPPING DIRECTION REVERSE CONNECTIONS TO TERMS 13, 12, 15, 14, 17, 16, 18, 19 OF KD-41 RELAY.

Fig. 18 External Schematic of Two Type KD-4 and one KD-41 Relays with Type TD-4 Timing Relay.

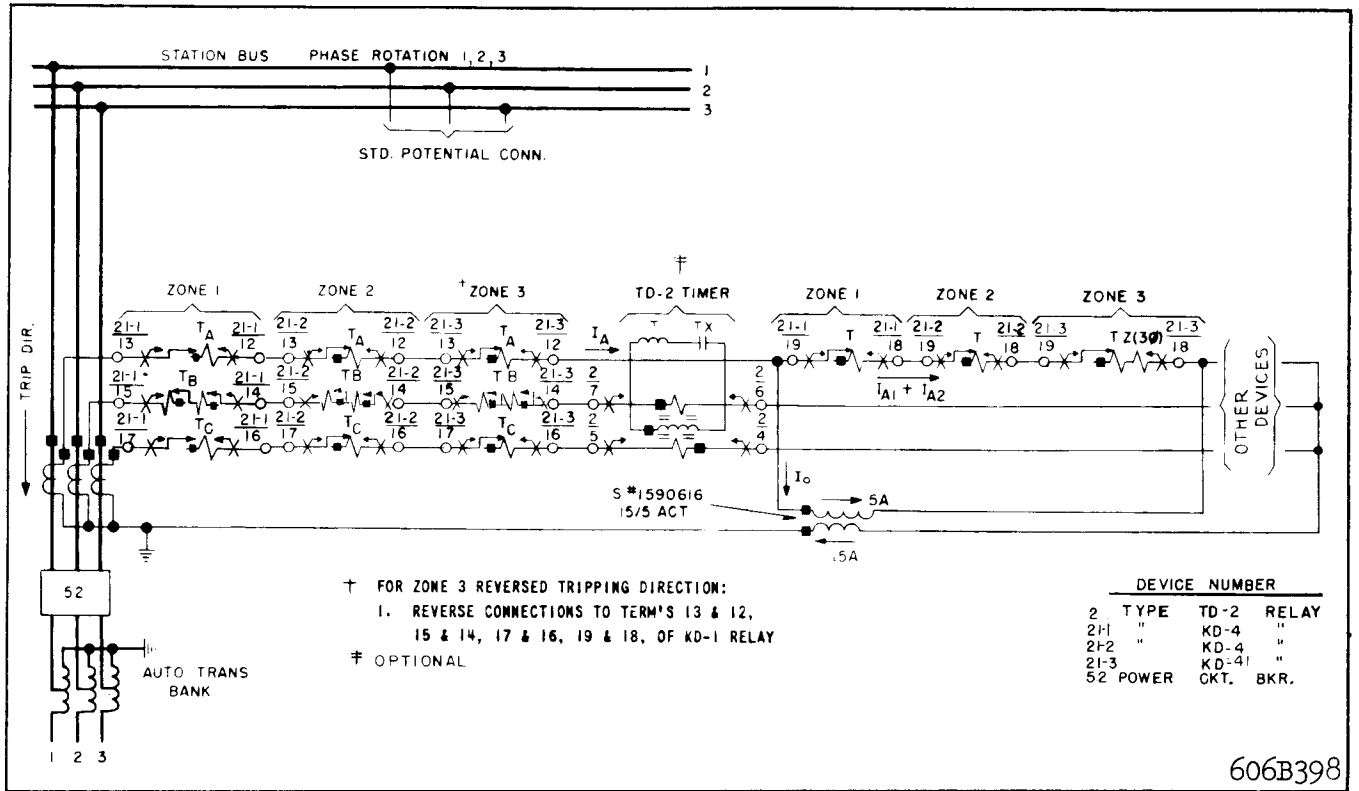

Fig. 19 A.C. External Schematic of Two Type KD-4 and One KD-41 Relay – Autotransformer Termination.

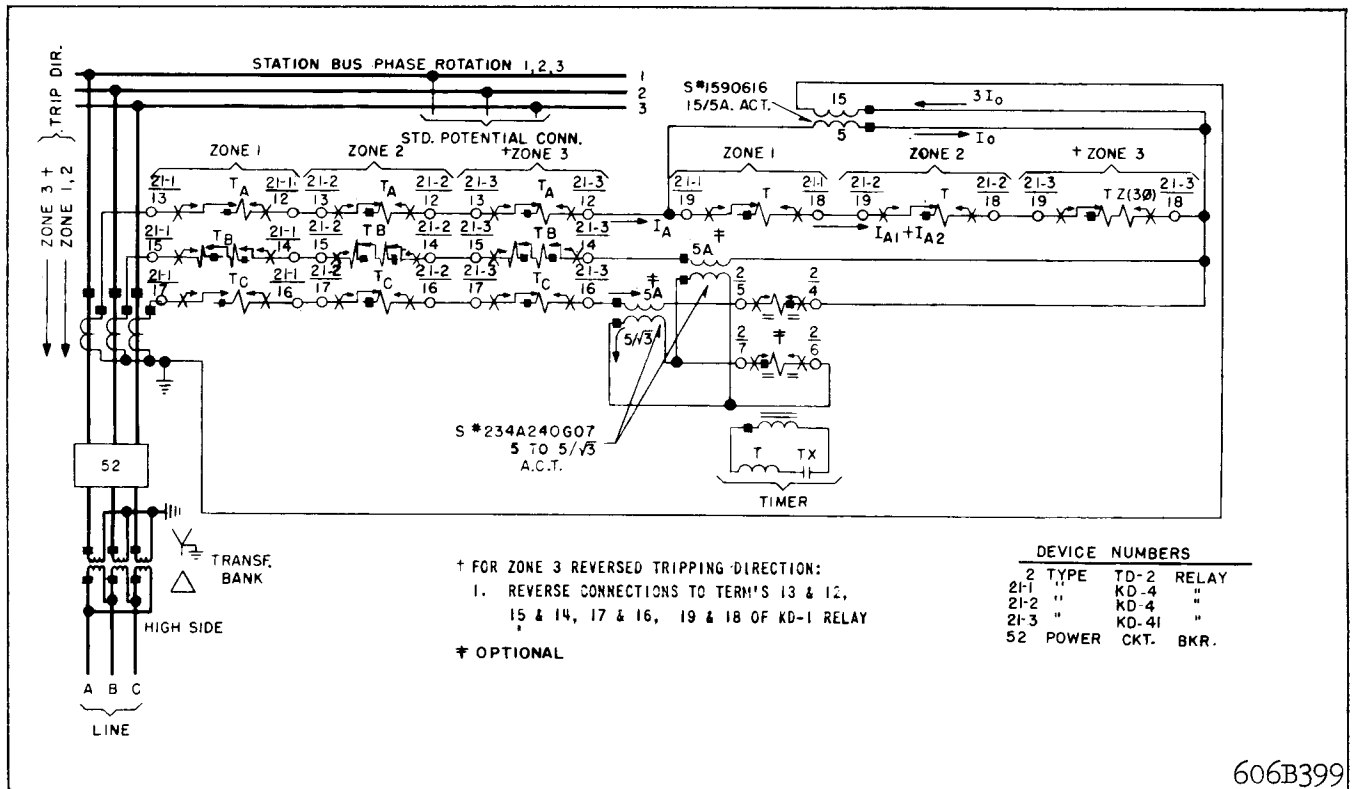

Fig. 20 A.C. External Schematic of Two Type KD-4 & One KD-41 Relay – Wye-Delta Bank Termination with Grounded Wye on Relay Side.

Burden

The burden which the relays impose upon potential and current transformers in each phase is shown by Figure 15 and Figure 16 for the KD-4 and KD-41 relays respectively. The potential burden and burden phase angle are based on 69 volts line-to-neutral applied to the relay terminals.

Trip Circuit Constants

1 ampere rating: 0.1 ohms d.c resistance
 0.2/2.0 ampere rating: 0.2 tap - 6.5 ohms
 2 tap - 0.15 ohms

SETTING CALCULATIONS

Relay reach is set on the tapplate shown in Fig. 3. The tap markings are:

T, T _A , T _B and T _C					
.87	1.16	1.45	2.03	2.9	4.06 5.8
S, S _A , and S _C					
1	2	3			
M, M _A , M _C					
.03	.09	.06			

(Values between taps)

Maximum torque angle is set for 75° (current lagging voltage) in the factory. This adjustment need not be disturbed for line angles of 65° or higher. For line angles below 65°, and zone 1 application set for a 60° maximum torque angle, by adjusting R₃, R_{2A} and R_{2C}. There is no need to make maximum torque angle adjustment for zone 2 or 3 application. Set zone 1 reach to be 90% of the line (85% for line angles of less than 50°).

Calculations for setting the KD-4 and KD-41 relays are straightforward and apply familiar principles. Assume a desired balance point which is 90 percent of the total length of line. The general formula for setting the ohms reach of the relay is:

$$Z_{\theta} = Z_{pri} \frac{0.9 R_c}{R_v}$$

The terms used in this formula and hereafter are defined as follows:

Z_{θ} = the desired ohmic reach of the relay in secondary ohms.

$Z = \frac{TS}{1 \pm M}$ = the tap plate setting.

T = compensator tap value

The tap plate values refer to standard maximum torque angle adjustment which is 75° for both units.

For relays having other than standard maximum torque angle adjustment Z-setting should be modified per procedure outlined below.

S = Auto-transformer primary tap value

θ = Maximum torque angle setting of the relay. This setting is made in line with recommendations made above.

(Factory setting of $\theta = 75^{\circ}$)

$\pm M$ = Auto-transformer secondary tap value. (This is a Per Unit value and is determined by the sum of the values between the "L" and the "R" leads. The sign is positive when "L" is above "R" and acts to Lower the Z setting. The sign is negative when "R" is above "L" and acts to raise the Z setting).

Z_{pri} = ohms per phase of the total line section.

0.9 = the portion of the total line for which the relay is set.

R_c = current transformer ratio

R_v = potential transformer ratio

The following procedure should be followed in order to obtain an optimum setting of the relay.

1. a) Establish Z_{θ} , as above
- b) Establish Z - Relay Tap Plate Settings. If the relay maximum torque angle θ has been recalibrated to an angle different from 75° setting, multiply the Z_{θ} value by factor $\frac{\sin 75^{\circ}}{\sin \theta^{\circ}}$.

If 75°, setting of θ is used $Z = Z_{\theta}$.

2. Now refer to Table I

Table I lists optimum relay settings for relay * range from .74 to 21.2 ohms.

- a) Locate a table value for relay reach nearest to the desired value Z (it will always be within 1.5% or less off the desired value).

- * b) Read off the Table "S," "T" and "M" settings. "M" - column includes additional information for "L" and "R" leads setting for the specified "M" value.

TABLE I
RELAY SETTINGS FOR KD-4 & KD-41 RELAYS

T	"S" = 1							"S" = 2		"S" = 3		"M"		LEAD CONNECTION	
	.87	1.16	1.45	2.03	2.9	4.06	5.8	4.06	5.8	4.06	5.8	+M	-M	"L" Lead	"R" Lead
.737	.98	1.23	1.72	2.46	3.44	4.92	—	9.83	—	14.7	+18		.06	0	"L" over "R"
.756	1.01	1.26	1.76	2.52	3.53	5.04	—	10.1	—	15.1	+15		.06	.03	
.777	1.04	1.29	1.81	2.59	3.63	5.18	7.26	10.4	—	15.5	+12		.09	0	
.798	1.06	1.33	1.86	2.66	3.72	5.32	7.45	10.6	—	16.0	+09		.09	.03	
.821	1.09	1.37	1.91	2.74	3.83	5.47	7.66	10.9	—	16.4	+06		.06	.09	
.845	1.13	1.41	1.97	2.82	3.94	5.63	7.88	11.3	—	16.9	+03		.03	0	
.870	1.16	1.45	2.03	2.90	4.06	5.80	8.12	11.6	—	17.4	0	0	0	0	"R" over "L"
.897	1.20	1.49	2.09	2.99	4.19	5.98	8.37	12.0	—	17.9		-.03	0	.03	
.926	—	1.54	2.16	3.09	4.32	6.17	8.64	12.3	—	18.5		-.06	.09	.06	
.956	—	1.59	2.23	3.19	4.46	6.37	8.92	12.7	—	19.1		-.09	.03	.09	
—	—	1.65	2.31	3.30	4.61	6.59	9.23	13.2	—	19.8		-.12	0	.09	
—	—	1.71	2.39	3.41	4.78	6.82	9.55	13.6	—	20.5		-.15	.03	.06	
—	—	—	—	—	—	7.07	—	* 14.14	14.8	21.2		-.18	0	.06	

▲ The tap plate values refer to standard maximum torque angle adjustment which is 75° for both units.

c) Recheck the obtained S,T,M- settings by using equation.

$$Z = \frac{S T}{1 \pm M}$$

For example, assume the desired reach, Z_{θ} is 7 ohms at 60°. (Step 1a)

Next step is (1b). If relay has been recalibrated to max. torque angle of the line (60°) that is different from setting of 75° find the relay setting $Z = 7 \times \frac{\sin 75^\circ}{\sin 60^\circ} = 7.77$ ohms.

Step (2a). In Table I we find nearest value to 7.77 ohms 7.88 that is $100 \frac{7.88}{7.77} = 101$ percent of the desired reach.

Step (2b). From Table I read off:

$$\begin{aligned} S &= 2 \\ T &= 4.06 \\ M &= +.03 \end{aligned}$$

and "L"- lead should be connected over "R"- lead, with "L" lead connected to "03"- tap and "R"- lead to tap "0".

Step (2c). Recheck Settings.

$$Z = \frac{S T}{1 \pm M} = \frac{2 \times 4.06}{1 + .03} = 7.88$$

or

$$Z_{60} = Z \frac{\sin 60^\circ}{\sin 75^\circ} = 7.88 \times .895 = 7.05 \text{ ohms}$$

or 1.0 percent of the desired setting.

SETTING THE RELAY

The KD-4 and KD-41 relays require settings for

each of the three compensators (T , T_{AB} , and T_{BC}), each of the auto-transformers, primaries (S , S_A , and S_C) and secondaries (M , M_A , and M_C). All of these settings are made with taps on the tap plate which is located between the operating units. Fig. 3 shows the tap plate.

Compensator (T , T_{AB} and T_{BC})

Each set of compensator taps terminate in inserts which are grouped on a socket and form approximately three quarters of a circle around a center insert which is the common connection for all of the taps. Electrical connections between common insert and tap inserts are made with a link that is held in place with two connector screws, one in the common and one in the tap. There are two T_B settings to be made since phase B current is passed through two compensators. A compensator tap setting is made by loosening the connector screw in the center. Remove the connector screw in the tap end of the link, swing the link around until it is in position over the insert for the desired tap setting, replace the connector screw to bind the link to this insert, and retighten the connector screw in the center. Since the link and connector screws carry operating current, be sure that the screws are turned to bind snugly.

Auto-Transformer Primary (S , S_A , and S_C)

Primary tap connections are made through a single lead for each transformer. The lead comes out of the tap plate through a small hole located just below or above the taps and is held in place on the tap by a connector screw. (Figure 3).

An "S" setting is made by removing the connector screw, placing the connector in position over the insert of the desired setting, replacing and tightening the connector screw. The connector should never make electrical contact with more than one tap at a time.

Auto-Transformer Secondary (M , M_A , and M_C)

Secondary tap connections are made through two leads identified as L and R for each transformer. These leads come out of the tap plate each through a small hole, one on each side of the vertical row of "M" tap inserts. The lead connectors are held in place on the proper tap by connector screws.

Values for which an "M" setting can be made are from -0.18 to $+0.18$ in steps of 0.03 . The value of a setting is the sum of the numbers that are crossed

when going from the R lead position to the L lead position. The sign of the "M" value is determined by which lead is in the higher position on the tap plate. The sign is positive (+) if the L lead is higher and negative (-) if the R lead is higher.

An "M" setting may be made in the following manner. Remove the connector screws so that the L and R leads are free. Determine from the following table the desired "M" value. Neither lead connector should make electrical contact with more than one tap at a time.

See Table I for tabulated "M" settings.

Line Angle Adjustment

Maximum torque angle is set for 75° (current lagging voltage) in the factory. This adjustment need not be disturbed for line angles of 65° or higher. For line angles below 65° , set for a 60° maximum torque angle by adjusting the compensator loading resistors R_3 , R_{2A} , and R_{2C} . Refer to repair calibration parts I (C) and II (B), when a change in maximum torque angle is desired.

Indicating Contactor Switch (ICS)

No setting is required for relays with a 1.0 ampere unit. For relays with a 0.2/2.0 ampere unit, connect the lead located in front of the tap block to the desired setting by means of the connecting screw. When the relay energizes a 125- or 250-volt d-c type WL relay switch, or equivalent, use the 0.2 ampere tap; for 48-volt d-c applications set the unit in a tap 2 and use a Type WL relay with a S#304C209G01 coil, or equivalent.

INSTALLATION

The relays should be mounted on switchboard panels or their equivalent in a location free from dirt, moisture, excessive vibration and heat. Mount the relay vertically by means of the mounting stud for the type FT projection case or by means of the four mounting holes on the flange for the semi-flush type FT case. Either the stud or the mounting screws may be utilized for grounding the relay. The electrical connections may be made directly to the terminals by means of screws for steel panel mounting or to the terminal stud furnished with the relay for thick panel mounting. The terminal stud may be easily removed or inserted by locking two nuts on the stud and then turning the proper nut with a wrench.

For detail information on the FT case refer to IL. 41-076.

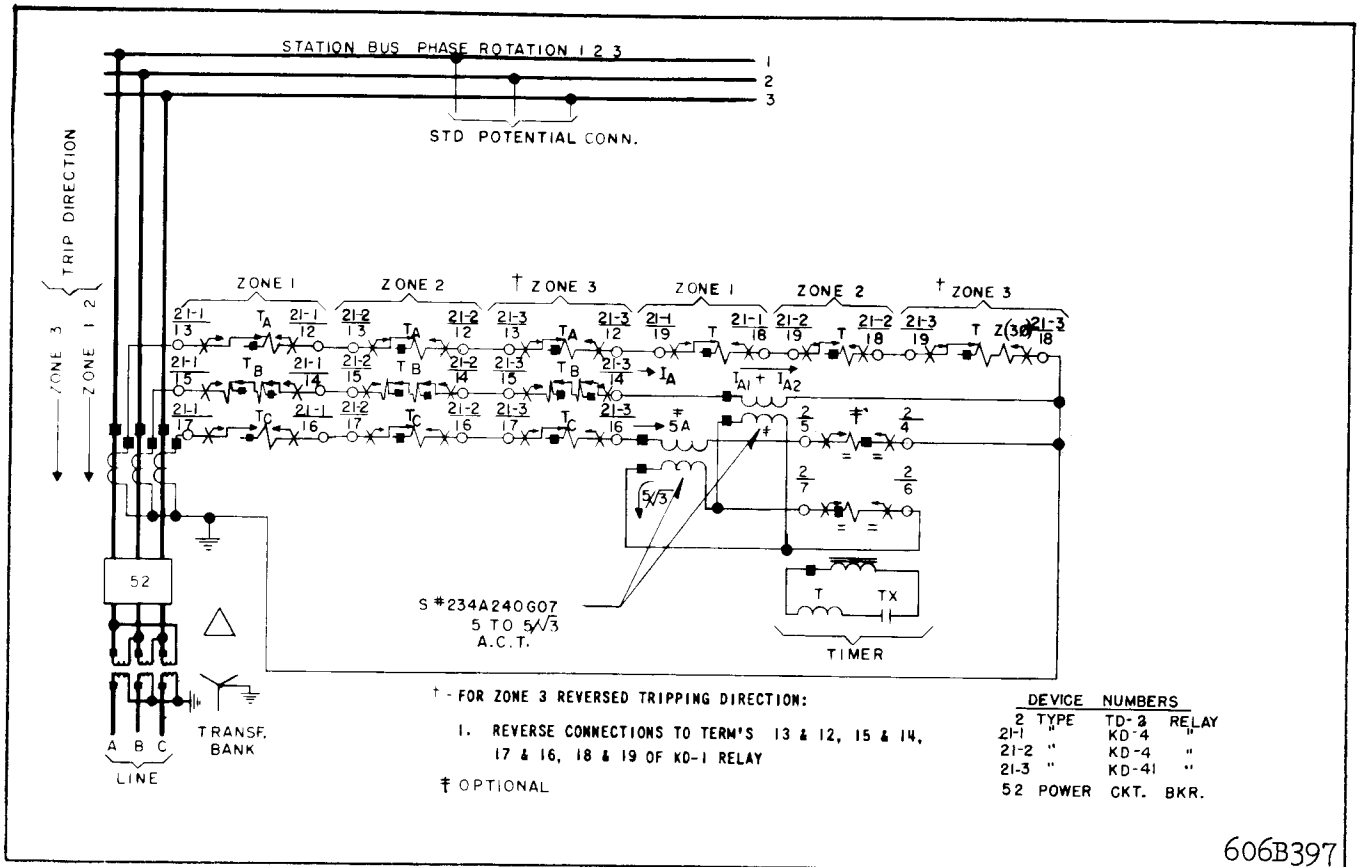

Fig. 21 A.C. External Schematic of Two Type KD-4 & one KD-41 Relay. Wye-Delta Bank Termination with Delta on Relay Side.

EXTERNAL CONNECTIONS

Fig. 17 shows the connections for 3 zone protection utilizing the TD-2 timer. Fig. 18 is similar to Fig. 17 except that the TD-4 timer is used instead of the TD-2. Fig. 18 does not show the use of the 5/5 auxiliary current transformer so that the CT neutral may be formed elsewhere; however, this connection is equally applicable whether the TD-2 or TD-4 timer is employed.

A-C connections for additional applications are shown in Figs. 19, 20, 21, 22 and 23. Three of these, Figs. 19, 20 and 21 apply when the transmission line is terminated in a power transformer, and when low side voltage and current are used to energize the relays. In calculating the reach setting, the bank impedance must be added to the line impedance.

For the case of a wye-delta bank (Figs. 20 and 21) the voltages and currents are phase-shifted by 30°; however, this fact should be ignored, as the KD-4 and KD-41 relays are not affected by this phase shift.

Fig. 22 shows a KD-41 and TD-5 relay connected for generator back-up protection.

Fig. 19 through 21 show the TD-2 relay; however, the TD-4 is equally applicable. In the case of Figs. 20 and 21 the two S#234A240G07 auxiliary CT'S are not required if the TD-4 is used.

SWITCHBOARD TESTING WITH KD-4 AND KD-41 RELAYS

Immediately prior to placing the relays in service, the external wiring can be checked by manipulating the current and voltage applied to the relay. If such a check is desired, refer to Appendix I for the procedure.

RECEIVING ACCEPTANCE

KD-4 and KD-41 relays have a very small number of moving parts and mechanical devices which might become inoperative. Acceptance tests in general consist of:

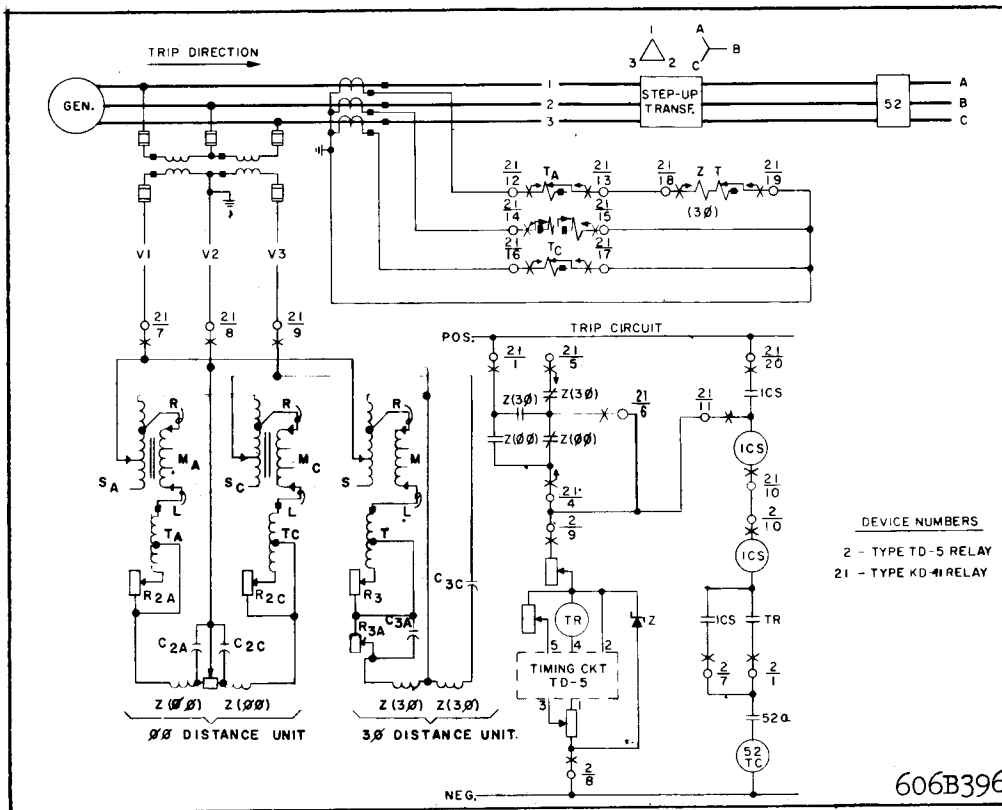

Fig. 22 External Schematic of Type KD-41 Relay with Type TD-5 Timing Relay for Generator Backup Protection.

1. A visual inspection to make sure there are no loose connections, broken resistors, or broken resistor wires.
2. An electrical test to make certain that the relay measures the balance point impedance accurately.

Distance Units

Check the electrical response of the relay by using the test connections shown in Figure 23. Set T, TA, TB, & TC for 5.8; SA, SC, & RS for 1, MA, MC for + 0.15.

- * A. Use connections for Test No. 1 and adjust the voltage V_{1F2F} and V_{1F3F} for 30 volts each.
- B. The current required to make the contacts close for the three-phase (bottom) unit should be between 3.45 and 3.65 amperes at the maximum-torque angle of 75° current lag. (Set phase shifter for 105° lag in Fig. 23).
- C. Use connection for Test No. 5.
- D. Adjust the voltage between PH.1 and IF and between PH.2 and 2F for 45 volts each so that the resultant voltage V_{1F2F} equals 30 volts. (120-45V-45V = 30V), in general,

$$V_{PH11F} = V_{PH22r} = \frac{V_{IN} - V_{1F2F}}{2}, \text{ for other}$$

than 125 volts input.

- E. The current required to make the contacts close for the phase-to-phase (top unit should be between 2.90 and 3.15 amperes at an angle of 75° current lag.

- F. Repeat E while using connections for Test No. 6 and Test No. 7. The difference in values of current that make the contacts close for each of the three test connections should not be greater than 3% of the smallest value.

* If relay is tested at other than S = 1 setting, double acceptance voltage for S=2, or triple for S=3.

If the electrical response is outside the limits a more complete series of test outlined in the section titled "Calibration" may be performed to determine which component is faulty or out of calibration.

Indicating Contactor Switch (ICS)

Close the main relay contacts and pass sufficient d-c current through the trip circuit to close the contacts of the ICS. This value of current should be not less than 1.0 ampere nor greater than 1.2 amperes for the 1 ampere ICS. The current should not be greater than the particular ICS tap setting being used for the 0.2-2.0 ampere ICS. The operation indicator target should drop freely.

The contact gap should be approximately 0.047" for the 0.2/2.0 ampere unit and 0.070" for the 1.0 ampere unit between the bridging moving contact and the adjustable stationary contacts. The bridging moving contact should touch both stationary contacts simultaneously.

ROUTINE MAINTENANCE

The relays should be inspected periodically, at such time intervals as may be dictated by experience, to insure that the relays have retained their calibration and are in proper operating condition.

All contacts should be cleaned periodically. A contact burnisher #182A836H01 is recommended for this purpose. The use of abrasive material for cleaning contacts is not recommended because of the danger of embedding small particles in the face of the soft silver and thus impairing the contact.

Distance Units

CAUTION: Before making "hi-pot" tests, jumper all contacts together to avoid destroying arc-suppressor capacitors.

Use connections for tests 1, 5, 6 & 7 of Fig. 23 to check the reach of the relay, or use a K-Dar Test unit for this purpose. When using test 1 of Fig. 23 the phase angle meter must be set for 30° more than the maximum torque angle. Note that the impedance measured by the 3-phase unit in test 1 is

$$Z_R = \frac{V_{L-L}}{\sqrt{3} I_L}$$

where V_{L-L} is the phase-to-phase voltage and I_L is the phase current; similarly, in tests 5, 6 & 7 of Fig.

$$23 \text{ the phase-to-phase unit measures } Z_R = \frac{V_{L-L}}{2I_L}$$

Indicating Contactor Switch (ICS)

Close the main relay contacts and pass sufficient d-c current through the trip circuit to close the contacts of the ICS. This value of current should be not less than 1.0 ampere nor greater than 1.2 amperes for the 1 ampere ICS. The current should not be greater than the particular ICS tap setting being used for the 0.2-2.0 ampere ICS. The operation indicator target should drop freely.

REPAIR CALIBRATION

Use the following procedure for calibrating the relay if the relay has been taken apart for repairs or the adjustments disturbed.

Connect the relay for testing as shown in Figure 23. The four-pole-double-throw switch shown in the test circuit selects the type of voltage condition, for a phase-to-phase or a three-phase fault, that will be applied to the relay voltage terminals. The rotary switch switches the fault voltage to various terminals and thereby simulates any combination of phase-to-phase faults without the tester having to change connections or readjust the phase shifter and variable auto-transformers.

For best results in checking calibration, the relay should be allowed to warm up for approximately one hour at rated voltage. However, a cold relay will check to within two percent of the warm relay.

Initial Spring Setting

With the stationary contacts open so that the moving contact cannot touch, set the moving contact spring adjuster so that the contact floats freely in the gap. Make sure that there is no friction which prevents free movement of the cylinder and contact arm.

Shaft Clearance

The upper pin bearing should be screwed down until there is approximately .025 inch (one complete turn of the screw) between it and the top of the shaft bearing. The upper pin bearing should then be securely locked in position with the lock nut. The lower bearing position is fixed and cannot be adjusted.

Autotransformer Check

Auto-transformers may be checked for turns ratio and polarity by using the No. 1 test connections of Figure 23, and the procedure outlined below.

Set S, S_A, and S_C on tap number 3. Set the "R" leads of M, M_A, M_C all on 0.0 and disconnect all the "L" leads. Adjust the voltages V_{1F2F} and V_{2F3F} for 90 volts. Measure the voltage from terminals 8 to the #1 tap of S and S_A. It should be 30 volts. From 8 to the #2 tap of S and S_A should be 60 volts. The voltage should read 30 volts from 8 to S_C = 1 and 60 volts from 8 to S_C = 2.

Set S, S_A and S_C on 1 and adjust V_{1F2F} and V_{2F3F} for 100 volts. Measure the voltage drop from terminal 8 to each of the M and the M_A taps. This voltage should be equal to 100(1 + the sum of values between R and the tap being measured). Example: 100(1 + .03 + .09) = 112 volts.

Check the taps of M_C in the same manner. Trans-

formers that have an output different from nominal by more than 1.0 volt probably have been damaged and should be replaced.

Distance Unit Calibration

Check to see that the taps on front of the tap block are set as follows:

T, T_A, T_B (twice) and T_C set on 5.8

S, S_A, and S_C set on 1

“R” for M, M_A, and M_C set on “03”.

“L” for M, M_A, and M_C set in the top position
(.06 + .09) = .15 between L & R).

I. THREE-PHASE UNIT

Core and R_{3A} Resistor Adjustments

Set R₃ resistor for 190 ohms. Adjustable part of R_{3A} should be connected for full resistance. Restraint Spring Set as above per Initial Spring Setting.

The relay should be preheated for at least one hour in the case with closed cover to eliminate change in tuning due to self-heating.

A. Connect relay terminals 8 and 9 together, apply, rated a-c voltage between terminals 7 and 8. Adjust core by turning it slightly until the contact arm floats or restrains very slightly.

B. For KD-4 only.

Connect relay terminals 7 and 8 together and apply rated a-c voltage between 7 and 9 and adjust core until the contact arm just floats or restrains very slightly. If this is not possible rotate core 90° and adjust. Recheck part A to see if contact is floating or restraining. If not, repeat parts A and B.

C. All Relays.

Connect relay for Test #7. Set V_{1F2F} for 2 volts. Set phase shifter so that voltage leads current by 75°. Make sure that applied voltage is of correct phase sequence. Adjust R_{3A} resistor so that 3 φ unit trips at 0.8 amp.

D. For KD-4 only.

The adjustable core is checked to prevent contact closing on current-only. (The KD-41 relay is purposely biased to produce current-only contact-closing torque and will open its right hand contact at a current value of 3 amperes or less when T = 5.8.)

Check it as follows:

1. Short circuit relay terminals 7, 8 and 9 together.
2. Pass 5 amperes in the current circuit in terminal 18 out terminal 19 and increase the current to 30 amperes in convenient steps.
3. Relay contacts should stay open. If contacts close turn core further 90 degrees and repeat parts A, B and C.

Maximum Torque Angle Adjustment

1. Use the No. 1 test switch positions and lead connections as tabulated in Figure 23.
- * 2. Adjust the voltages V_{1F2F} and V_{1F3F} for 30 volts with Brush No. 1 and Brush No. 2 respectively.

3. Adjust the current to 8 amperes and rotate the phase shifter to find the two angles, θ₁ and θ₂, at which the bottom unit contacts just close. The maximum torque angle θ for the

three-phase unit then is $(\frac{\theta_1 + \theta_2}{2} - 30)$ degrees.

This angle should be between 73° and 76° for a nominal 75° adjustment. Phase shifter reading of 103° to 106° in Fig. 23)

4. A smaller angle may be obtained by reducing R₃, in which case the test current should be

$$\text{equal to } \frac{8 \sin 75^\circ}{\sin \theta} \text{ amperes. The angle may}$$

be increased by increasing R₃.

Contact Adjustment

KD-4 Relay: With moving-contact arm against right-hand backstop, screw the stationary contact in until it just touches the moving contact. (Check for contact by using an indicator lamp.) Then back the left-hand contact out two-thirds (2/3) of one turn to give 0.020-inch gap between contacts.

KD-41 Relay: With moving-contact arm against right-hand side of bridge, screw the right-hand contact in to just touch the moving contact and then continue for one more complete turn. Adjust left-hand contact as described above, except back off one and one-half (1-1/2) turns to give approximately 0.047-inch gap.

Spring Restraint:

Reconnect for a three-phase fault, Test No. 1, and set the phase shifter so

that the current lags voltage by the maximum-torque angle. (105° in Fig. 23) Adjust the spring so that the current required to close the left-hand contact is as follows:

Voltages V_{1F2F} and V_{2F3F}	= 10 volts
Current to trip KD-4	= 1.27 amperes
Current to trip KD-41	= 1.3 amperes.

De-energize Relay. Spring should reset the contacts.

II. PHASE-TO-PHASE UNIT

Core and R_{AC} - Adjustment

A) No current is applied to relay. Set R_{AC} - resistor so that the adjustable band is in the center of the resistor.

* Restraint Spring Set as above per Initial Spring Setting.

B) Connect terminals 7 & 8 together and apply rated a-c voltage between terminals 8 - 9. Adjust core until contact arm floats in the middle of the gap. Use a screwdriver with insulated blade to avoid accidental contact with tap plate inserts.

C) Connect terminals 8 & 9 together and apply rated a-c voltage between terminals 7 and 8. The contact arm should float. If not, readjust the core. Only slight readjustment should be necessary. If this not possible rotate core 90° and adjust. Then recheck B to see if contact is floating.

D) Connect terminals 7 & 9 together. Apply rated a-c voltage to terminals 7 & 8. Adjust resistor R_{AC} , until contact arm floats. Use R_{AC} - small resistor where available for fine adjustment.

Maximum Torque Angle Adjustment (Fig. 23)

1. Use the No. 2 Test switch position and lead connections. This connection is for checking and adjusting the maximum torque angle of the T_{AB} compensator.

* 2. Adjust the voltage V_{1F2F} and V_{1F3F} for 50 volts with Brush No. 1 and Brush No. 2 respectively.

3. Adjust the current to 10 amperes and rotate the phase shifter to find two angles, θ_1 and θ_2 , at which the top unit contacts just close. The maximum torque angle θ for the phase-to-

phase unit then is $(\frac{\theta_1 + \theta_2}{2} - 30)$ degrees.

This angle should be between 73° and 77° :

This angle θ can be changed by adjusting R_{2A} .

In this case, the test current should be equal

to $\frac{10 \sin 75^\circ}{\sin \theta}$ amperes. A lower value of re-

sistance gives a smaller angle, and a higher resistance value gives a greater angle.

4. Use the No. 4 Test Connections and repeat the above procedure to check and adjust the angle of the TBC - compensator. This adjustment is made with R_{2C} .

Final Core and R_{AC} Adjustment (Fig. 23)

1. Connect Relay for 1-2 fault as indicated for Test No. 5.

2. Adjust the voltage between PH1 and 1F and between PH2 and 2F for 59 volts each using Brush No. 1 and Brush No. 2 respectively to provide 2 volts between 1F and 2F ($V_{1F2F} = 120 - 59 - 59 = 2$ volts). With no current relay contacts should stay open. If relay contacts are closed recheck voltage settings, incorrect voltage setting may result in negative sequence voltage phasing.

3. Set phase shifter for maximum torque angle.

4. Check pickup current. It should be between .20-.21 amps. If not rotate core slightly until pickup current falls within specified range.

5. Connect relay for 2-3 fault (Test No. 6) and recheck pickup. It should be within limits specified. For best trip calibration results adjust core so that trip current for Test No. 5 and No. 6 are equal.

6. Connect relay for Test No. 7. Check trip current. It should be .20-.21 amp. If not readjust R_{AC} slightly for the same trip current as for Test No. 5 and No. 6.

Spring Restraint (Fig. 23)

1. Use Test No. 1 connections except reverse the voltage phase sequence by interchanging the Brush connections so that Brush 1 is connected to 3F and Brush 2 is connected to 1F.

2. Adjust the voltage V_{1F2F} and V_{2F3F} for 3.5 volts each with Brush No. 2 and Brush No. 1 respectively. Position the moving-contact spring adjuster so that the contact just floats and then return the circuit connections to

normal with Brush 1 to 1F and Brush 2 to 3F. De-energize Relay. Spring should reset the contacts.

E. Any compensator that has an output which is 2 volts more or less than the nominal values given above should be replaced.

Contact Adjustment

The procedure for contact adjustment for the phase-to-phase unit is identical to that described for three-phase unit.

The phase-to-phase unit is now calibrated and should be accurate to within $\pm 2\%$ of the corrected tap value setting over the range of fault voltages from $5 V_{L-L}$ to $120 V_{L-L}$. The corrected tap value is actual relay reach at a given maximum torque angle

$$\theta \text{ and is equal to } Z_{\theta} = \frac{TS \sin \theta}{(1 \pm M) (\sin 75^{\circ})}$$

The relay is now calibrated and ready for service.

III. COMPENSATOR CHECK

Accuracy of the mutual impedance Z_C of the compensators is set within very close tolerances at the factory and should not change under normal conditions. The mutual impedance of the compensators can be checked with accurate instruments by the procedure outlined below.

- A. Set T, T_A , T_B , T_C , and T_C on the 5.8 tap.
- B. Disconnect the "L" leads of sections M, M_A , and M_C and the brush leads of R_3 , R_{2A} , and R_{2C} . (With resistor loading removed $\theta = 90^{\circ}$).
- C. Connect terminals 12 to 14, 15 to 17, 16 to 18 and pass 10 amperes a.c current in terminal 19 and out of terminal 13.
- D. Measure the compensator voltage V_C with a high resistance voltmeter (5,000 ohm/volt) as tabulated below. Refer to Figure 1 for the location of R_3 , R_{2A} , and R_{2C} .

Measure V_C		Voltmeter Reading
From Terminal	To Fixed End of	
"L" of M	R_3	$V_C = 1.5 I T \left(\frac{\sin \theta}{\sin 75^{\circ}} \right)$ = 90.1 volts ($\theta = 90^{\circ}$)
"L" of M_A	R_{2A}	$V_C = 2 I T \left(\frac{\sin \theta}{\sin 75^{\circ}} \right)$ = 120 volts ($\theta = 90^{\circ}$)
"L" of M_C	R_{2C}	

IV. OVERALL CHECK

After the calibration procedure has been completed, perform the following check:

Set all T = 5.8, all S = 1, all M = + .15

A. Three-Phase Unit

Connect the relay for a three-phase fault, Test No. 1 of Figure 23, and set the phase shifter so that the phase angle meter indicates 30° more than the maximum torque angle. The current required to trip the relay should be within the limits specified for each of the voltages. Note that for the three-phase unit

$$\text{the impedance measured by the relay is } Z_R = \frac{V_{L-L}}{\sqrt{3} I_L}$$

where V_{L-L} is phase-to-phase fault voltage and I_L is phase current.

Volts	Amperes ($\theta = 75^{\circ}$) † † & †	
	I_{min}	I_{max}
V_{1F2F} & V_{1F3F}		
10	-	* 1.28 KD-4 1.3 KD-41
30	3.44	3.6 KD-4 3.65 KD-41
70	7.85	8.1 Both

† to determine the limits of current when θ is not equal to 75° , multiply the nominal values tabulated above by the ratio $\frac{\sin 75^{\circ}}{\sin \theta}$.

† † Phase angle meter set for $\theta + 30^{\circ}$.

B. Phase-to-Phase Unit

Using the connections for Tests Nos. 5, 6 and 7, set the phase shifter so that the current lags voltage by θ° . The current required to trip the phase-to-phase unit should be within the limits specified for each of the voltages. Note that for the phase-to-phase unit the impedance measured by the relay is

$$Z_R = \frac{V_{L-L}}{2 I_L} \text{ where } V_{L-L} \text{ is phase-to-phase fault voltage and } I_L \text{ is phase current.}$$

Test No.	Volts	Amperes ($\theta = 75^\circ$) †	
	V _{1F2F}	I _{min}	I _{max}
5, 6 & 7	5.0	0.48	0.54
	30.0	2.90	3.15
	70.0	6.80	7.10

† To determine the limits of current when θ is not equal to 75° , multiply the nominal values tabulated

above by the ratio $\frac{\sin 75^\circ}{\sin \theta}$.

Indicating Contactor Switch (ICS)

Close the main relay contacts and pass-sufficient d-c current through the trip circuit to close the con-

tacts of the ICS. This value of current should not be less than 1.0 ampere nor greater than 1.2 amperes for the 1 ampere ICS. The current should not be greater than the particular ICS tap setting being used for the 0.2-2.0 ampere ICS. The operation indicator target should drop freely.

The contact gap should be approximately 0.047" for the 0.2/2.0 ampere unit and 0.070" for the 1 ampere unit, between the bridging moving contact and the adjustable stationary contacts. The bridging moving contact should touch both stationary contacts simultaneously.

RENEWAL PARTS

Repair work can be done most satisfactorily at the factory. However, interchangeable parts can be furnished to the customers who are equipped for doing repair work. When ordering parts, always give the complete nameplate data.

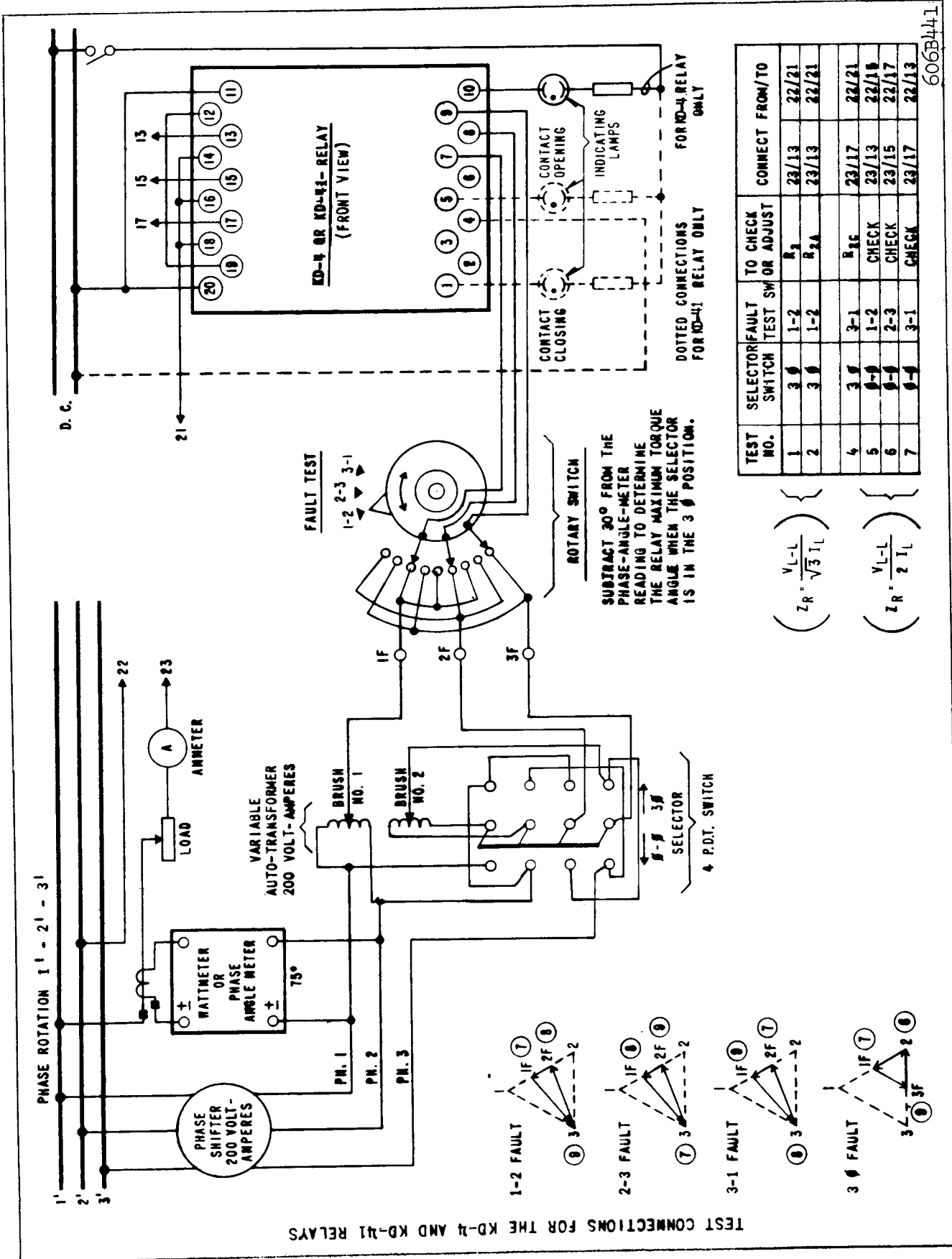

606B441

Fig. 23 Test Connections for Type KD-4 and KD-41 Relays.

TABLE II

NOMENCLATURE FOR RELAY TYPE KD-4 & KD-41

UNIT	ITEM	DESCRIPTION
THREE-PHASE	Z (3 ϕ)	Two Element-Coils; Total d-c Resistance = 200 to 240 ohms.
	Z (3 ϕ) 2-3	Two Element-Coils; Total d-c Resistance = 540 to 660 ohms.
	R _{3A} , R _{3F}	2 Resistors, Total Resistance 3500 ohms For KD-4
	R _{3A} , R _{3F}	2 Resistors, Total Resistance 6240 ohms For KD-41
	R ₃	2-inch Resistor 300 ohms Adjustable
	C _{3A}	1.35 MFD Capacitor
	C _{3C}	0.30 MFD Capacitor (.6 M FD For KD-41)
	T	Compensator (Primary Taps - .87; 1.16; 1.45; 2.03; 2.9; 4.06; 5.8)
	S	Auto-Transformer Primary (Taps - 1; 2; 3)
	M	Auto-Transformer Secondary (Between Taps - 0.0; .03; .09; .06)
	X _L	Reactor (Not in KD-41)
	Z (ϕ - ϕ)	Two Element-Coils; Total d-c Resistance = 160 to 200 ohms.
	PHASE-TO-PHASE	RAC
R _{2A} , R _{2C}		2 inch Resistor 900 ohms Adjustable
C _{2A} C _{2C}		1.35 MFD Capacitor.
T _{AB} T _{BC}		Compensator Same as T
S _A S _C		Same as S
M _A M _C		Same as M
	* I _{AC}	2-inch resistor 75 ohms

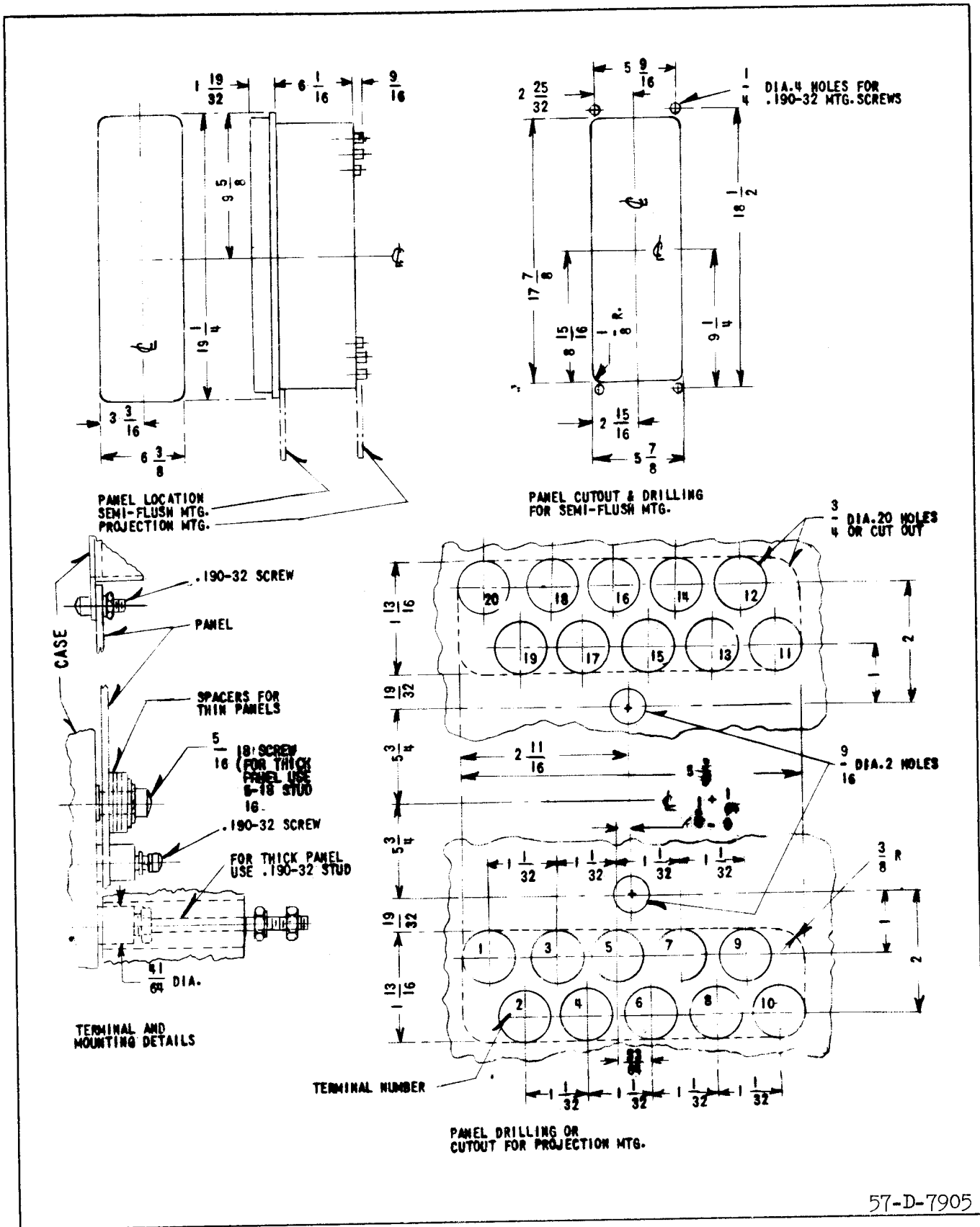

Fig. 24 Outline and Drilling Plan for the Type KD-4 and KD-41 Relays in The Type FT 42 Case.

APPENDIX I

SWITCHBOARD TESTING WITH KD-4 AND KD-41 RELAYS

External connections may be checked by the relay, provided there is sufficient load current flow at a known power factor angle. Relay current may be at least $\frac{7}{T}$ -amperes (1.2 amps when $T=5.8$). This check is appropriate prior to commissioning the relay or when trouble shooting.

Potential Circuit Check

Close the three relay potential switches numbered 7, 8 and 9, (Figure 17). The connection for the proper phase sequence will be indicated by a strong contact-opening torque. Closing torque will indicate reverse-phase sequence.

Current Verification

To verify the proper current connections use the following procedure:

1. Read watt, vars and amperes. The current should be at least 1.2 amperes.
2. Plot watts and vars on the diagram in Fig. 25. Draw a line at the load angle determined by this plot. Designate this line as I_{REF} . See Fig. 26 for example.
3. Set $T = 5.8$, $S = 1$ for maximum sensitivity. (Lower taps may be used, provided current exceeds $7/T$).
4. Perform the 9 switching combinations in Table IV, recording the relay contact position for each combination. (Actually only 6 combinations are needed to verify the currents, so that any group of three need not be used. This is important where the load angle falls too close to the zero torque line. If the indicated power-factor angle is within 3° of the test limit for any group of three tests, these should be ignored.)
5. Verify the currents using the procedure illustrated in Table IV. Here the "correct contact position" is determined by observing whether the I_{REF} line in Fig. 26 intersects the solid or dashed part of circle. (For example, test 1b shows a solid circle indicating that the contacts should close.) Next compare the actual contact positions to the correct ones.
6. If the contact positions are proper, the current connections are correct and the test is complete, otherwise proceed to identify the currents using the following procedure.

Current Identification

If the verification check discloses incorrect current connections, the following procedure may be used to determine what is wrong. However, if one set of three switching combinations places the relay too close to the zero-torque line, use conventional techniques instead, since identification requires all 9 switching combinations.

1. Plot aI_{REF} and a^2I_{REF} at 120° angles from I_{REF} . See Fig. 26 for example. These currents are related to the phase currents as shown in the following table:

Phase Receiving Current	I_{REF}	a^2I_{REF}	aI_{REF}
1	I_{PH1}	I_{PH2}	I_{PH3}
2	I_{PH2}	I_{PH3}	I_{PH1}
3	I_{PH3}	I_{PH1}	I_{PH2}

2. Prepare a table similar to Table V using Fig. 26. For example, for test 1b the contacts were open. Such a result would occur if I_{REF} of the wrong polarity is actually flowing in the phase 1 circuits of the relay. This conclusion is drawn by noting that I_{REF} in Fig. 26 intersects the solid part of the test 1b circle. This says that if $+I_{REF}$ is flowing the contacts would close. Since the contacts actually open, then $-I_{REF}$ could be flowing. Similarly, for test 1b, $-a^2I_{REF}$ could be flowing, since the a^2I_{REF} line also intersects the solid part of the test 1b circle.

By the process of elimination for each set of 3 tests, the actual current is identified. For example, in Table V, phase 1 receives $-I_{PH1}$, whereas $+I_{PH1}$ should be flowing. In phase 2, $+I_{PH3}$ is flowing as shown in Fig. 27. To extract this bit of information from Table V, use the above table relating the phase currents to I_{REF} , a^2I_{REF} and aI_{REF} .

Note in Table V that a^2I_{REF} is flowing in the phase 2 circuits of the relay. The above table shows for this set of 3 tests that $a^2I_{REF} = I_{PH3}$.

3. Correct the external connections and then verify the currents.

TABLE III

SWITCHING FOR CURRENT VERIFICATION AND IDENTIFICATION

Switching Combination	Position of switches numbered:							Unit which should be Observed	Phase Receiving Current
	Voltage sw.			Current sw. (blank indicates open sw.)					
	V ₁	V ₂	V ₃	I ₁	I ₂	I ₃	I ₁		
	7	8	9	12, 13	14, 15	16, 17	18, 19 (3φ)		
1	Open & jump sw. jaw to 9	Closed	Closed	a		Closed		φ-φ&†	3
				b	‡ Closed		* ‡ Closed	φ-φ& 3φ	1
2	Closed	Open & jump sw. jaw to 7	Closed	a	Closed		Closed	φ-φ& 3φ	1
				b		Closed		φ-φ&†	2
3	Closed	Closed	Open & jump sw. jaw to 8	a		Closed		φ-φ&†	2
				b			Closed	φ-φ&†	3
4	Closed	Closed	Open & jump sw. jaw to 7	‡ Closed			Closed	φ-φ& 3φ	1
5	Open & jump sw. jaw to 8	Closed	Closed		Closed			φ-φ&†	2
6	Closed	Open & jump sw. jaw to 9	Closed			Closed		φ-φ&†	3

† Block 3φ Unit Open

* ‡ If Current is Over 5 Amps.

TABLE IV

VERIFICATION EXAMPLE USING ASSUMED LOADING OF FIG. 26

PHASE TO BE VERIFIED	SWITCHING COMBINATION	CORRECT CONTACT POSITION	ACTUAL CONTACT POSITION	
			IF WIRING IS CORRECT	EXAMPLE WITH INCORRECT WIRING
1	1b	C	C	O
	2a	C	C	O
	4	O	O	C
2	2b	C	C	C
	3a	C	C	O
	5	O	O	C
3	3b	C	C	O
	1a	C	C	O
	6	O	O	O

TABLE V

IDENTIFICATION EXAMPLE USING ASSUMED LOADING OF FIG. 26

I _{REF.} PHASE RECEIVING CURRENT	SWITCHING COMBINATION	EXAMPLE OF CONTACT POSITION	CURRENT & POLARITY WHICH CAN PRODUCE OBSERVED CONTACT POSITION					
			I _{REF.}	a ² I _{REF.}	aI _{REF.}			
1	1b	O	<table border="1" style="display: inline-table; vertical-align: middle;"> <tr><td>-</td></tr> <tr><td>-</td></tr> <tr><td>-</td></tr> </table> †	-	-	-	-	+
	-							
	-							
-								
2a	O	+	+					
4	C	+	-					
2	2b	C	<table border="1" style="display: inline-table; vertical-align: middle;"> <tr><td>+</td></tr> <tr><td>+</td></tr> <tr><td>+</td></tr> </table> †	+	+	+	+	-
	+							
	+							
+								
3a	O	-	+					
5	C	-	-					
3	3b	O	<table border="1" style="display: inline-table; vertical-align: middle;"> <tr><td>+</td></tr> <tr><td>+</td></tr> <tr><td>+</td></tr> </table> †	+	+	+	-	+
	+							
	+							
+								
1a	O	+	+					
6	O	+	-					

† See Fig. 27 for actual connections.

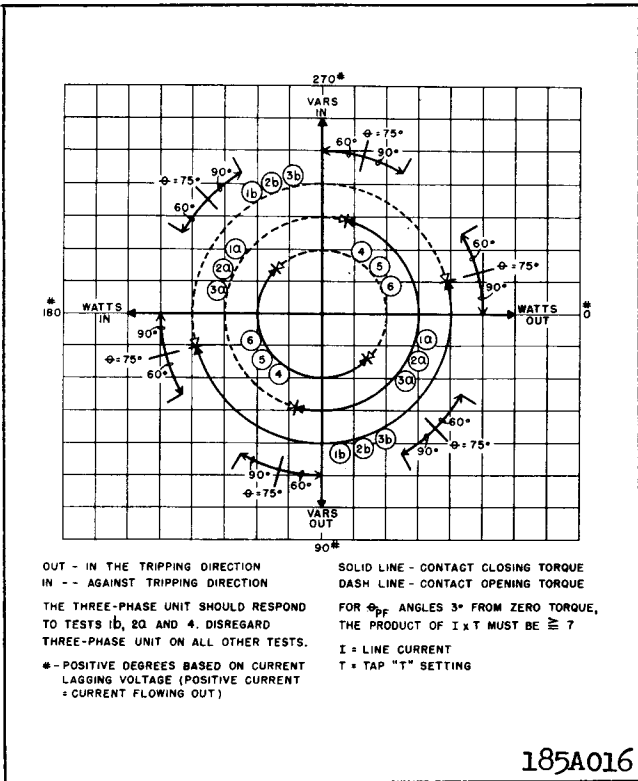

Fig. 25 Phase Diagram for Current Circuit Verification and Identification.

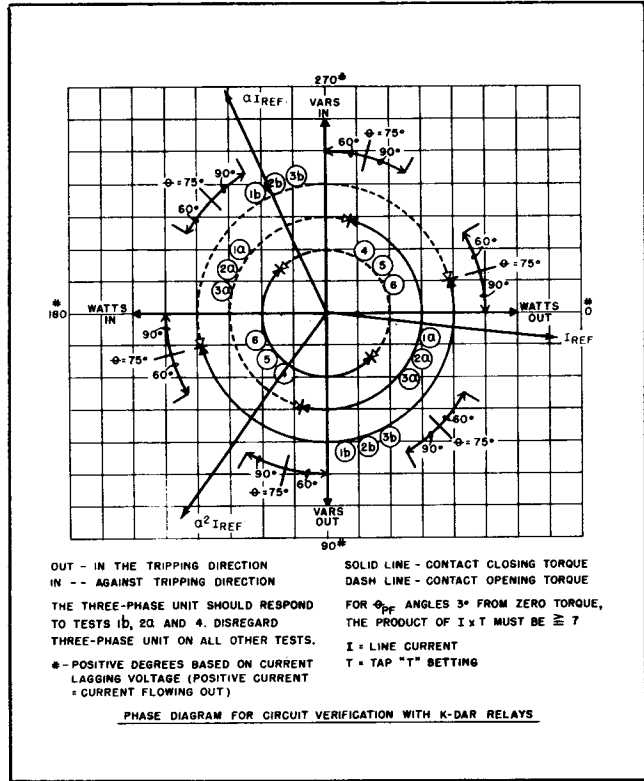

Fig. 26 Phase Diagram Showing Assumed Load Conditions for an Example.

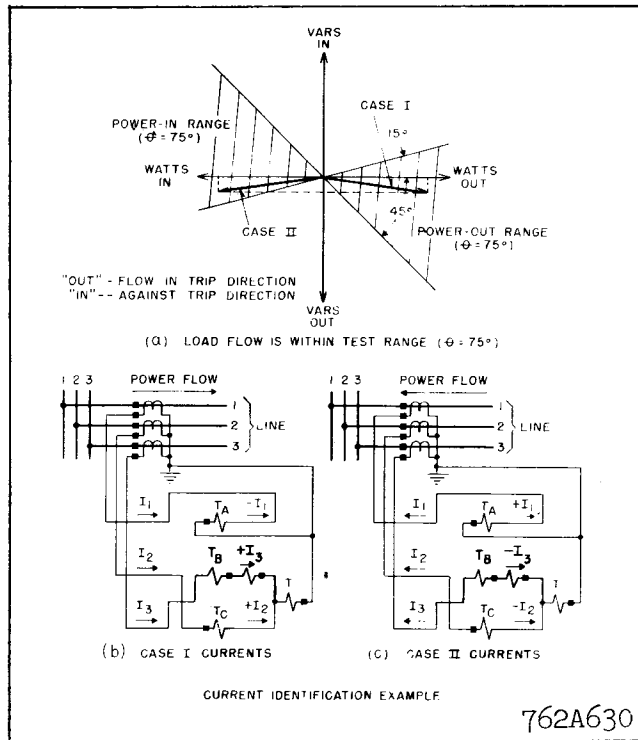
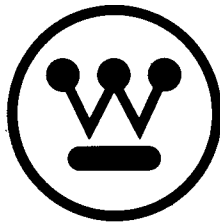

Fig. 27 Actual Wiring for the Assumed Test Results of Table V.



WESTINGHOUSE ELECTRIC CORPORATION
RELAY-INSTRUMENT DIVISION

NEWARK, N. J.

Printed in U.S.A.